

COOL-SAVE

Development and dissemination of cost-effective strategies to improve energy-efficiency in cooling systems in the food and drink sector

Best Practice Guide



ania
Asociación Nacional de
Industrias Alimentarias

 **ClimaCheck**

Campden BRI 

GEA

FEDERALIMENTARE
Federazione Italiana dell'Industria Alimentare

FIAB
Federación Española de Industrias
de la Alimentación y Bebidas



ITCL
Instituto Tecnológico de Castilla y León

 **okavango**
by energy & climate partners



Best practice guide on
how to save energy in
food and drink companies' cooling systems

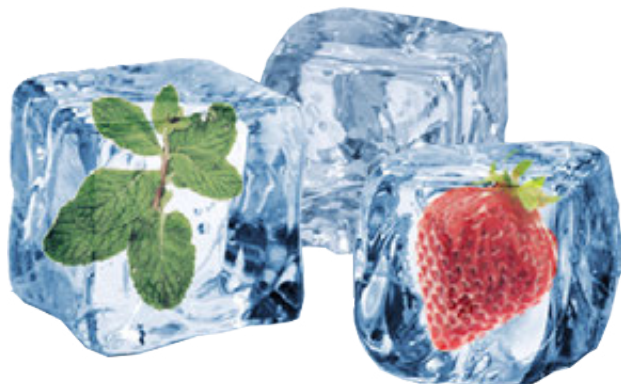

This publication has been produced with the assistance of the European Union. The content of this publication is sole responsibility of the authors and can in no way be taken to reflect the views of the European Union.

Acknowledgements:

We would like to express thanks to the following people for their time and efforts in commenting on the various chapters of the guide, and who contributed with their practical knowledge and technical expertise.

We are grateful also to the organisations who provided case studies and examples, and who allowed their staff to participate and generally supported our work.

**‘COOL-SAVE’ Development and dissemination of cost effective strategies to improve energy efficiency in cooling systems in the food and drink sector funded by Intelligent Energy Europe Programme
(grant agreement n° IEE/11/003/SI2.615920)**

Working Group Members:

Rubén Renilla, Maite Cobo, Maurizio Notarfonso, Viola Katalin, Attila Berczeli, Istvan Gabor, Laura Marley, Françoise Gorga, Adrienn Hegyi, Ina Colombo, Pascal Araujo, Klas Berglöf, Jaime Sines, Javier Miguel Gonzalez, David Gonzalez

Project coordinators:

Maite Cobo and Ruben Renilla, ITCL - Instituto Tecnológico de Castilla y León (Spain)

CONTENTS

INTRODUCTION	9
1. HOW TO USE THIS GUIDE	13
1.1 STEP 1: OBTAINING LISTS OF PERSONALIZED SAVING STRATEGIES FOR EVALUATED REFRIGERATION PLANTS ...	13
1.1.1 Method 1: Cool-Save Web Tool	14
1.1.2 Method 2: Obtaining a generic saving strategy list by selection criteria	14
1.2 STEP 2: ANALYSIS AND SELECTION OF SAVING STRATEGIES TO IMPLEMENT	15
1.3 STEP 3: MONITORING OF THE IMPACT OF THE IMPLEMENTATION OF ENERGY SAVINGS STRATEGIES	15
2. FOREWORD	17
3. SHORT OVERVIEW OF THE STATE OF THE ART IN COOLING SYSTEMS IN THE FOOD & DRINK SECTOR	21
3.1 ECONOMIC OVERVIEW OF THE FOOD AND DRINK SECTOR	22
3.1.1 Number of companies per segment	22
3.1.2 Annual turnover per segment	23
3.1.3 Number of employees	24
3.1.4 Energy consumption	24
3.1.5 Location of the plants	25
3.1.6 Emissions of NH ₃	26
3.2 TECHNICAL INFORMATION ABOUT THE FOOD AND DRINK SECTOR	26
3.2.1 Evolution of the industrial refrigeration system	27
3.2.2 Refrigeration System and Type of Refrigerant	28

3.3	EFFECT OF COOLING PARAMETERS ON ENERGY CONSUMPTION	32
3.3.1	Production and load on compressors	32
3.3.2	Installed equipment	32
3.3.3	Control strategy	33
3.3.4	Geographical location	33
3.4	CONCLUSIONS	34
4.	BASELINE DATA FOR EVALUATION OF ENERGY CONSUMPTION	37
4.1	REQUIRED ENERGY INFORMATION FOR EVALUATION OF OPTIMISATION PROJECTS	38
4.2	CLIMATE INFORMATION	39
4.3	ENERGY AND POWER PROFILE	40
4.4	ANNUAL ENERGY CONSUMPTION BASED ON THE POWER PROFILE	41
4.5	ANALYSING THE PERFORMANCE OF THE REFRIGERATION PROCESS	42
4.6	COEFFICIENT OF PERFORMANCE - COP AS A PERFORMANCE INDICATOR	42
4.7	SYSTEM EFFICIENCY INDEX - SEI AS A PERFORMANCE INDICATOR	43
4.8	REQUIRED MEASUREMENTS FOR PERFORMANCE ANALYSES	45
5.	INVENTORY OF BEST ENERGY SAVING STRATEGIES	49
5.1	LOAD REDUCTION	49
5.1.1	Objective	49
5.1.2	Technical Description	50
5.1.3	Technical Requirements and Recommendations	50

5.1.4	Energy Saving Potential.....	51
5.1.5	Implementation Cost and Return on Investment.....	51
5.2	REDUCTION OF HEAT LOSSES AND PRESSURE DROPS IN REFRIGERATION SYSTEM	51
5.2.1	Objective.....	51
5.2.2	Technical Description	51
5.2.3	Technical Requirements and Recommendations.....	60
5.2.4	Energy Saving Potential.....	60
5.2.5	Implementation Cost and Return on the Investment.....	61
5.3	CYCLE OPTIMISATION.....	63
5.3.1	Objective.....	63
5.3.2	Technical Description	63
5.3.3	Technical Requirements and Recommendations.....	68
5.3.4	Energy Saving Potential.....	69
5.3.5	Implementation Cost and Return on the Investment.....	69
5.4	OPTIMISATION OF CONDENSER PERFORMANCE.....	70
5.4.1	Objective.....	70
5.4.2	Technical Description	70
5.4.3	Technical Requirements and Recommendations.....	72
5.4.4	Energy Saving Potential.....	72
5.4.5	Implementation Cost and Return on the Investment.....	73
5.5	OPTIMISATION OF EVAPORATOR PERFORMANCE.....	75
5.5.1	Objective.....	75
5.5.2	Technical Description	75
5.5.3	Technical Requirements and Recommendations.....	76
5.5.4	Energy Saving Potential.....	76
5.5.5	Implementation Cost and Return on the Investment.....	77
5.6	REDUCTION OF AUXILIARY LOADS	78
5.6.1	Objective.....	78
5.6.2	Technical Description	78
5.6.3	Technical Requirements and Recommendations.....	80
5.6.4	Energy Saving Potential.....	80
5.6.5	Implementation Cost and Return on the Investment.....	81

5.7	OPTIMIZATION OF COMPRESSOR PERFORMANCE.....	82
5.7.1	Objective.....	82
5.7.2	Technical Description	82
5.7.3	Technical Requirements and Recommendations.....	87
5.7.4	Energy Saving Potential.....	87
5.7.5	Implementation Cost and Return on the Investment.....	89
5.8	HEAT RECOVERY AND FREE COOLING	90
5.8.1	Objective.....	90
5.8.2	Technical Description	90
5.8.3	Technical Requirements and Recommendations.....	95
5.8.4	Energy Saving Potential.....	95
5.8.5	Implementation Cost and Return on the Investment.....	96
5.9	IMPROVED CONTROL STRATEGIES.....	97
5.9.1	Objective.....	97
5.9.2	Technical Description	97
5.9.3	Technical Requirements and Recommendations.....	103
5.9.4	Energy Saving Potential.....	103
5.9.5	Implementation Cost and Return on the Investment.....	105
5.10	LIST OF BEST SAVING STRATEGIES WITH LOWEST RETURN ON INVESTMENT (ROI)	107
6.	MAP OF EXISTING GRANTS SHOWING THE FUNDING OPPORTUNITIES AT NATIONAL LEVEL.....	109
6.1	COUNTRY OUTLOOK: SPAIN	109
6.1.1	CDTI Technology Fund.....	109
6.1.2	Financing characteristics	109
6.1.3	Feder-Innterconecta.....	110
6.1.4	Instructions for supporting Personnel Expenses.....	110
6.1.5	JESSICA - F.I.D.A.E. Fund.....	110
6.1.6	Other grants.....	112
6.2	COUNTRY OUTLOOK: HUNGARY	112
6.2.1	Hungarian energy strategy 2030 priorities.....	112
6.2.2	The European Agricultural Fund for Rural Development.....	113
6.2.3	Open calls for proposals in Hungary	114

6.3	COUNTRY OUTLOOK: UNITED KINGDOM	116
6.3.1	UK national energy efficiency action plan 2014 to 2015	116
6.3.2	Department of Energy & Climate Change (DECC)	116
6.3.3	Energy related funds and initiatives in the United Kingdom	117
6.3.4	Other fundings and initiatives	120
6.4	COUNTRY OUTLOOK: FRANCE	123
6.4.1	Financing systems	123
6.4.2	Investment aid	123
6.4.3	Energy savings certificate scheme (“Certificats d’économies d’énergie”)	124
6.4.4	Loans	126
6.4.5	Calls for expression of interest and financial support through calls for proposals	126
6.5	COUNTRY OUTLOOK: ITALY	127
6.5.1	Energy Demand	127
6.5.2	Final Energy Consumption	127
6.5.3	Use of energy in the agro-food sector	128
6.5.4	Review of the Italian instruments to improve energy efficiency	128
6.5.5	More links	131
6.6	COUNTRY OUTLOOK: BELGIUM	131
6.6.1	Financing systems	131
6.7	COUNTRY OUTLOOK: GERMANY	133
6.7.1	Industry and tertiary sector	133
6.8	COUNTRY OUTLOOK: SWEDEN	135
6.8.1	Total final energy use	135
6.8.2	The industrial sector	136
6.8.3	Sweden Programme for Improving Energy Efficiency in Energy Intensive Industries (PFE)	136
6.8.4	The Swedish Energy Agency	137
7.	REFERENCES	139

8. LIST OF ABBREVIATIONS	142
9. REFRIGERATION PLANTS ENERGY EFFICIENCY DIAGNOSTIC WEB TOOL	143
9.1 WEB TOOL DESCRIPTION.....	144
9.1.1 Main page	144
9.1.2 Login page.....	145
9.1.3 Available reports.....	145
9.1.4 Fill in a report	146
9.1.5 Final report.....	146
10. FACTSHEETS CASE STUDIES FROM AUDITED PLANTS.....	149
11. LIST OF FIGURES	159
12. LIST OF TABLES.....	161

INTRODUCTION

This document was prepared within the framework of the COOL-SAVE project “Development and dissemination of cost-effective strategies to improve energy-efficiency in cooling systems in the food and drink sector”. The aim of this document is to provide clear technical and financial information on the recommended energy saving strategies for each climate zone. Relevant information generated during the project has been compiled by technical and economic experts, providing different points of view. The guide includes a map of grants, at the national level, with information on co-financing the implementation cost of the strategies listed in the guide. The ambition of the project team is to have finalised a concise and concrete document, comprehensible to all the decision-makers in the sector, such as technical/financial directors in food and drink processing companies as well as other concerned stakeholders.

COOL-SAVE...in a nutshell

Overall objective of the project

The main objective of COOL-SAVE is to optimise the vapour-compression mechanical systems in the food and drink sector, the biggest manufacturing sector in the EU, with a global turnover of 815 billion euros in 2004 (14% of the total industry turnover), and employing 4 million persons. The COOL-SAVE project aims to reduce industrial energy consumption in vapour-compression mechanical system cooling installations in the food and drink sector through the dissemination of cost-effective energy efficiency strategies.



Providing appropriate innovation

Cooling and air conditioning systems account for around 15 – 20% of world energy consumption. Cooling installations based on vapour-compression mechanical systems, which have a large untapped energy saving potential, are used in more than 90% of industrial cooling installations. Due to their significant energetic impact, effective and realistic saving strategies are needed. The solution proposed is to develop cost-effective energy efficiency strategies for food and drink company cooling systems. These strategies will be obtained by using real data taken from companies' installations, simulations obtained through Energy Management Tools and cost-benefit analyses.

Energy efficiency and competitiveness of the Food & Drink industry

A key element of this project is the use of an Energy Analysis Tool that will measure a series of critical parameters vis-à-vis energy consumption, analyse the performance of the cooling system (Coefficient of Performance) and calculate the most relevant work efficiencies of the different elements that constitute the installation. The tool will not only analyse the Mollier thermodynamic cycle (P-H) of the installation but will also maximize performance by managing and deciding the best control strategies adapted to the conditions of both production and demand, according to weather conditions.

Project Essentials

Project Acronym: COOL-SAVE

Programme: CIP-EIE-2011

Project Start Date: 01/04/2012

Contract n°: IEE/11/003/SI2.61592

Duration: 36 months

Total Budget: € 1.751.544

EC Contribution: €1.313.658

Website: www.cool-save.eu



Spain

- ▶ Instituto Tecnológico de Castilla y León - ITCL
- ▶ Federación Española de Industrias de Alimentación y Bebidas – FIAB



Hungary

- ▶ Campden BRI Magyarország Nonprofit Korlatolt FelelosseguTarsasag – CBHU



France

- ▶ Okavango Energy - Okavango
- ▶ ANIA – Association Nationale des Industries Alimentaires
- ▶ International Institute of Refrigeration – IIFIIR



Italy

- ▶ Federalimentare Servizi srl – FEDSERV



The Netherlands

- ▶ GEA Refrigeration Technologies GmbH - GEA



Sweden

- ▶ • ClimaCheck Sweden AB

For more information

The banner features the COOL-SAVE logo at the top left. Below it are social media and contact icons: a globe icon for the website www.cool-save.eu, an envelope icon for info@cool-save.eu, a Facebook icon for www.facebook.com/CoolSave, and a Twitter icon for [@CoolSave](https://twitter.com/CoolSave). The background includes a light blue gradient with ice cube graphics. At the bottom, a 'Partners' section lists logos for ITCL, Capaden BVI, a green circular logo, FIAB (Finnish Refrigeration Association), GEA, FEDERAL INDUSTRIAL GROUP, ania, and ClimaCheck.

HOW TO USE THIS GUIDE

This guide is prepared in the aim of allowing Food & Drink companies with significant refrigeration needs to identify the best energy saving strategies to implement.

The guide consists of the best strategies based on data collected in real refrigeration plants during the Cool Save project. Each saving strategy contains the following information:

- ▶ Objective to achieve
- ▶ Description of the saving strategy
- ▶ Energy saving potentials based on real cases
- ▶ Return of the investment value approach
- ▶ Requirements to implement the saving strategy

1.1 STEP 1: OBTAINING LISTS OF PERSONALIZED SAVING STRATEGIES FOR EVALUATED REFRIGERATION PLANTS

Firstly, using information from the refrigeration plant to evaluate, a personalized list of saving strategies should be obtained.

The strategies chosen will be those which guarantee the highest energy saving with the lowest investment.

To evaluate the refrigeration plant and to obtain the best possible saving strategy list, the guide proposes two possible methods.

- ▶ **The first and most recommended method**, is to use the Web Tool developed within the framework of the Cool-Save Project.
- ▶ **The second method** is based on the selection of the best saving strategies according to classification criteria in the document explained below, under the point “Method 2”.

In addition to the pointers provided in this guide, it is also recommended to consult technical experts specialized in refrigeration techniques. This kind of expertise would be helpful in evaluating the refrigeration plants and identifying the best possible energy saving strategies to implement.

1.1.1 METHOD 1: COOL-SAVE WEB TOOL

One of the results of the Cool-Save project is a Web Tool designed to help perform a basic evaluation of the energy saving potential of the refrigeration plants.

This Web Tool is available on the Cool-Save web page (www.cool-save.eu).

The application consists of a simple questionnaire where energetic, economic and technical data on the refrigeration plant is requested. With the information entered, a simple energetic analysis is performed, and as a result, a list of the best viable energy improvement options is offered for each facility. Each improvement strategy is accompanied by an estimation of the annual maximum and minimum energy and cost savings.

It is possible to consult the Web Tool manual in this Guide to use it or download it from the Cool-Save webpage.

1.1.2 METHOD 2: OBTAINING A GENERIC SAVING STRATEGY LIST BY SELECTION CRITERIA

As part of the Cool-Save bibliography, you can find the document “D.4.1 Study focused on the economic and technical feasibility of the generic energy efficiency optimization solutions proposed according to the strategies implemented”.

This document contains an analysis of the factors than make the different saving strategies more or less suitable for each refrigeration plant. The best energy saving strategies to implement can be chosen as a function of these factors.

It is possible to identify the best saving strategies by consulting section 4 and section 5 of the aforementioned document. The factors to take into account are as follows:

- ▶ Generic energy saving solutions in terms of cooling technology
- ▶ Generic energy saving solutions in terms of plant size
- ▶ Generic energy saving solutions in terms of product lines
- ▶ Generic energy saving solutions in terms of climate zones

1.2 STEP 2: ANALYSIS AND SELECTION OF SAVING STRATEGIES TO IMPLEMENT

For each refrigeration plant, the strategies to be implemented should be chosen from the list obtained in step 1.

The main criteria that are recommended to be used are:

- ▶ Level of investment needed
- ▶ Return of the investment period.

Depending on the funds available, each company should select which strategies it is able to finance.

Consulting the section “Inventory of best energy saving strategies” of this guide will help to obtain the information needed to make a sensible decision. The information needed is listed as follows:

- ▶ Energy saving potential
- ▶ Estimated necessary level of investment
- ▶ Estimated Return of Investment
- ▶ Saving strategy implementation requirements

1.3 STEP 3: MONITORING OF THE IMPACT OF THE IMPLEMENTATION OF ENERGY SAVINGS STRATEGIES

When using the Web Tool to obtain a list of saving strategies, the application asks to confirm which of the strategies are going to be implemented.

This application provides the option to validate the savings and compare them with the initial estimated value.

It is recommended to enter real data in the Web Tool once the saving strategies have been implemented.

COOLSAVE

Development and dissemination of cost-effective strategies to improve energy-efficiency in cooling systems in the food and drink sector

COOL-SAVE is an **innovative project** which aims at **reducing industrial energy consumption in cooling installations** by vapor-compression mechanical system in the food and drink sector, through the dissemination of **cost-effective energy-efficiency strategies implementation**.

The main objective; to **optimize the vapor-compression mechanical systems** in the food and drink sector.

New Refrigeration plant energy-efficiency diagnostic webtool

- Calculate estimated potential energy savings
- Develop a customized improvement strategy

Sign up online at cool-save.eu/webtool



Have your say!

Are you a refrigeration professional?

Do you have something to say about energy savings in commercial refrigeration applications?

Take the **COOL-SAVE survey today** at cool-save.eu

Get involved in one of the leading European projects on energy saving strategies for cooling systems.

Before getting started, why not view the presentation on *"Economic and technical feasibility of generic energy efficiency optimization solutions."*

FOREWORD

Cooling and air conditioning systems account for around 15 – 20%¹ of world energy consumption. **Cooling installations based on vapour-compression mechanical systems, which have a large untapped energy saving potential,** are used in more than 90% of industrial cooling installations. Due to their significant energetic impact, **effective and realistic saving strategies are needed.**

The main objective of COOL-SAVE is to optimise **the vapour-compression mechanical systems in the food and drink sector,** the biggest manufacturing sector in the EU, with a global turnover of 815 billion euros in 2004 (14%² of the total industry turnover), and employing 4³ million persons.

The industrial refrigeration systems based on vapour-compression mechanical systems are designed to satisfy maximum thermal demands taking into consideration adverse weather conditions. But many systems, during most hours, do not function in the conditions for which they were designed and thus operate at partial loads or in different ambient conditions from those considered in the initial design of the plant. Most systems prove to not have been commissioned or optimized over a variety of loads and climate conditions, resulting in poor performance over the year.

The COOL-SAVE project aims **to reduce industrial energy consumption in cooling installations based on vapour-compression mechanical systems in the food and drink sector through the dissemination of cost effective energy efficiency strategies implementation.**

The solution proposed is to develop cost-effective energy efficiency strategies for food and drink company cooling systems. These strategies will be obtained by using real data taken from companies' installations, simulations obtained through Energy Management Tools and cost-benefit analysis.

¹ *Saving energy in refrigeration air conditioning and heat pump technology, International Institute of Refrigeration – IIR guides*

² *CIAA data*

³ *Eurostat data*

A key element of this project is the use of an Energy Analysis Tool that will measure a series of critical parameters vis-à-vis energy consumption, analyse the performance of the cooling system (COP) and calculate the most relevant work efficiencies of the different elements that constitute the installation.

The tool will not only analyse the Mollier thermodynamic cycle (P-H) of the installation but will also maximize performance by managing and deciding the best control strategies adapted to the conditions of both production and demand, according to weather conditions.

National and international workshops have been organized to involve the food and drink industry and to make them aware of the implementation of energy efficiency strategies to reduce energy consumption in cooling systems and also to obtain their feedback in order to improve the quality of the project outputs.

The Major outputs & expected results of the project are:

- ▶ Analysis of the energy-efficiency of representative cooling systems belonging to food and drink companies.
- ▶ Development of common best practices to reduce the electrical energy consumption of cooling systems in the food and drink industry.
- ▶ Elaboration of a guide to help food and drink companies implement concrete measures to significantly reduce their electrical consumption through the optimisation of their cooling systems.
- ▶ Spreading the results of the project to all European food and drink sector companies.

As a result of the COOL-SAVE project cost-effective energy efficiency strategies in food and drink cooling systems have been implemented based on real data from companies' installations. This data has been processed with Energy Management Tools and a cost-benefit analysis for implementation has been performed.

These results have been documented in this Guide of best practices, which is the key output of the project. It aims to compile the main strategies used to optimize the cooling systems, thus reducing the electrical consumption of food and drink companies in all the different climate areas identified.

In order to elaborate this guide, the results of the audits performed with the help of the Energy Analysis Tools, the opinions of leading companies within the food and drink sector, as well as those from professionals in charge of the installation of industrial cooling systems have been taken into account.

Moreover, an appendix has also been compiled with the different financial grants available at a regional or national level in a number of countries, which could be used to implement systems that improve power efficiency of the industrial cooling systems.

This guide aims at making industries aware of the different options available in order to reduce electrical consumption through the optimization of their cooling systems.

COOLSAVE

Development and dissemination of cost-effective strategies to improve energy-efficiency in cooling systems in the food and drink sector

COOL-SAVE is an **innovative project** which aims at **reducing industrial energy consumption in cooling installations** by vapor-compression mechanical system in the food and drink sector, through the dissemination of **cost-effective energy-efficiency strategies implementation**.

The main objective; to **optimize the vapor-compression mechanical systems** in the food and drink sector.

New Refrigeration plant energy-efficiency diagnostic webtool

- Calculate estimated potential energy savings
- Develop a customized improvement strategy

Sign up online at cool-save.eu/webtool



Have your say!

Are you a refrigeration professional?

Do you have something to say about energy savings in commercial refrigeration applications?

Take the **COOL-SAVE survey today** at cool-save.eu

Get involved in one of the leading European projects on energy saving strategies for cooling systems.

Before getting started, why not view the presentation on *"Economic and technical feasibility of generic energy efficiency optimization solutions."*

SHORT OVERVIEW OF THE STATE OF THE ART IN COOLING SYSTEMS IN THE FOOD & DRINK SECTOR

Table 3.1 - Definitions and abbreviations used in this report

COP	Coefficient of performance - ratio of heating or cooling provided to electrical energy consumed
ODP	Ozone Depleting Substances – substances that contribute to the destruction of ozone in the atmosphere which increase the rate of skin cancer and have other negative influences on biological life on earth
ODS	Substances that have an ODP – contribute to destroy ozone layer
GWP	Global Warming Potential – The relative influence on global warming
GHG	Green House Gas Emissions CO ₂ equivalent

Refrigerant families with ODP

CFC	Chlorofluorocarbons: High ODP substance (high GWP) i.e. R12 and R11
HCFC	Hydrochlorofluorocarbons: i.e. R22, R124, R123 (lower ODP high GWP)

Refrigerants with zero ODP but significant GWP

HFC	Hydrofluorocarbons: i.e. R134a, R404A, R410A
-----	--

Refrigerants with zero ODP and low GWP

HFO	Hydro-Fluoro-Olefins: i.e. R1234yf, R1234ez
-----	---

Refrigerants with zero ODP and near zero GWP (often called “natural refrigerants”)

HC	Environmentally benign but flammable hydrocarbons
R717	Ammonia - environmentally benign but toxic and slightly flammable
R744	Carbon dioxide

LCA	Life Cycle Analyses
LCC	Life Cycle Cost
TEWI	Total Equivalent Warming Impact – is a combined value of the impact of a system on global warming include leakage, end of life emissions and energy consumption
VSD	Variable frequency drives, or Variable speed drives
DC electric motors (brushless)	High efficiency motors also known as EC motors
EC motors	Electronically commutated high efficiency motors

As a first step in the selection of plants to be analyzed within the COOL-SAVE project the economic and technical/productive information of the food and drink sector were studied. Based on this study the production plants of this sector were categorized and the most representative plants were identified.

In the Economical study of the sector, the following aspects have been taken into consideration:

- ▶ Number of companies per segment
- ▶ Annual turnover per segment and size of companies
- ▶ Number of employees
- ▶ Purchases of energy products
- ▶ Location of cooling plants
- ▶ Emission of NH₃

In the technical study, information regarding the following aspects has also been taken into consideration:

- ▶ Evolution of the industrial refrigeration market
- ▶ Cool refrigeration system and type of refrigerant
- ▶ Annual energy consumption (kWh), estimated consumption of refrigeration systems and efficiency ratio

3.1 ECONOMIC OVERVIEW OF THE FOOD AND DRINK SECTOR

3.1.1 NUMBER OF COMPANIES PER SEGMENT

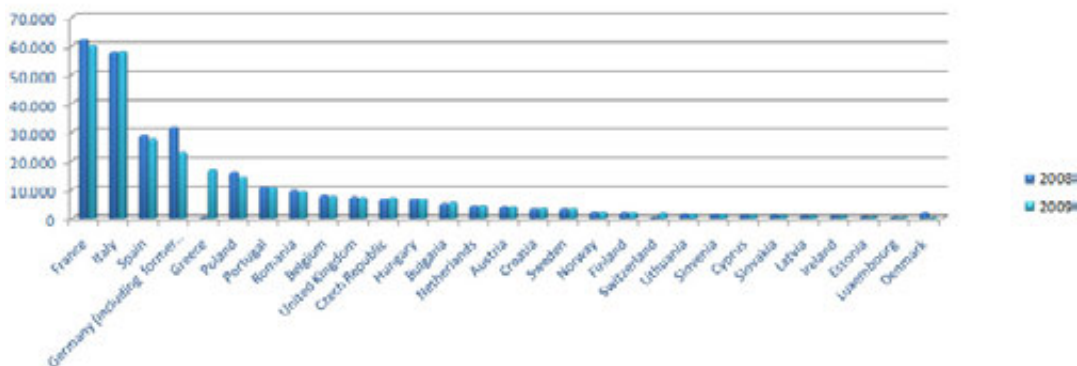

Figure 3.1 - Number of enterprises

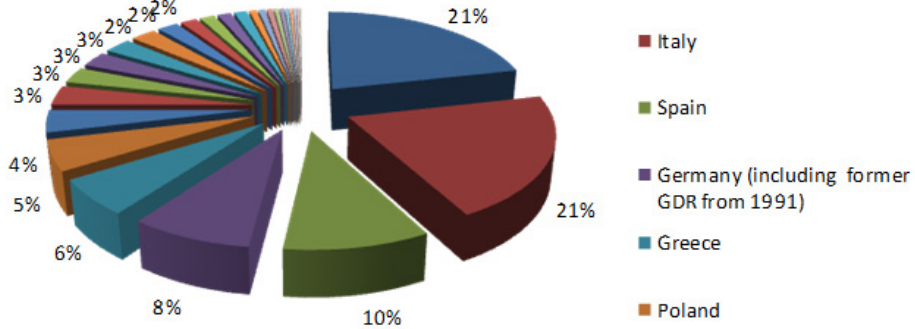

Figure 3.2 - % of industries per country

France, Italy, Spain, Germany and Greece are responsible for 66% of total industry operation. The five most significant segments are: bakery and farinaceous products, preserved meat and meat products, other food products, beverages and dairy products.

3.1.2 ANNUAL TURNOVER PER SEGMENT

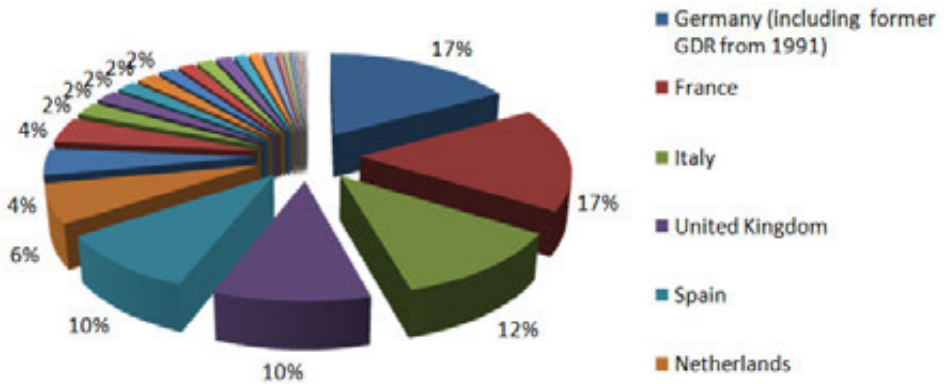

Figure 3.3 - % of turnover per country

The five countries with the greatest turnover are Germany, France, Italy, the United Kingdom and Spain. The five most interesting segments are: preserved meat and meat products, other food products, beverages, dairy products, bakery and farinaceous products.

3.1.3 NUMBER OF EMPLOYEES

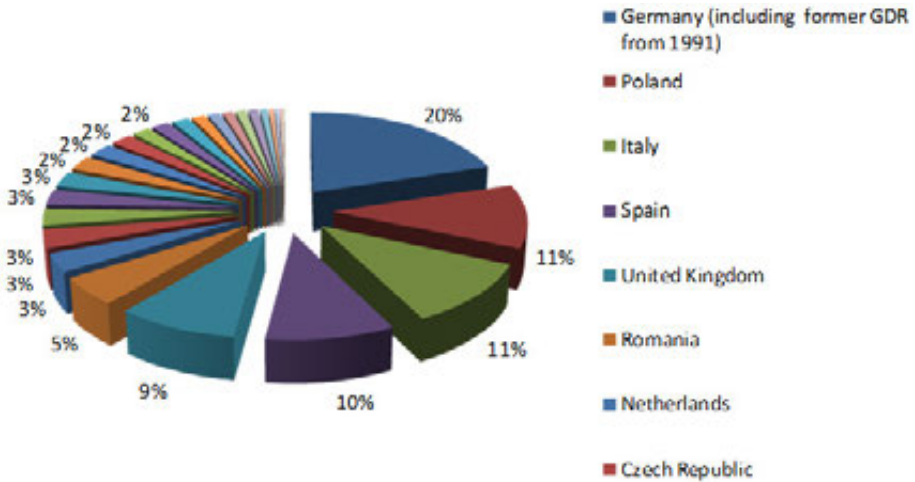

Figure 3.4 - % number of employees per country

The five countries with the largest number of employees are Germany, Poland, Italy, Spain and the United Kingdom. The five segments which employ the most people are: bakery and farinaceous products, preserved meat and meat products, other food products, beverages, and dairy products.

3.1.4 ENERGY CONSUMPTION

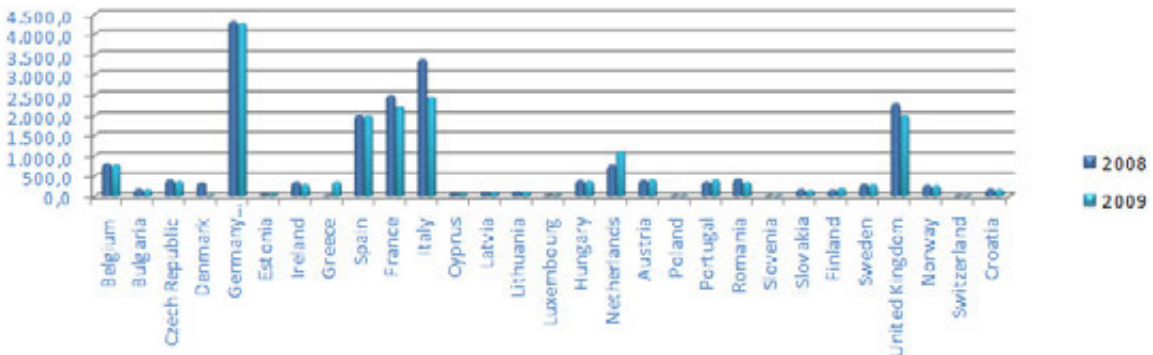

Figure 3.5 - Purchase of energy products (in value)

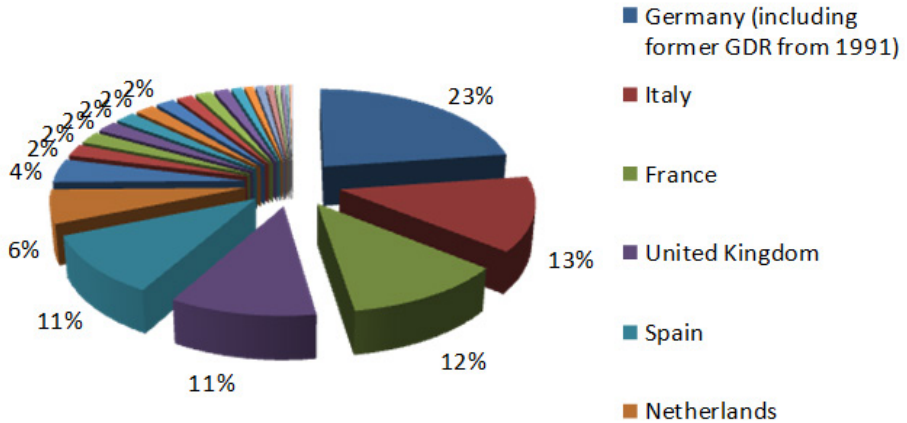

Figure 3.6 - % of purchased products per country

The five most relevant countries vis-à-vis the number of purchased products are Germany, Italy, France, The United Kingdom and Spain, whereas the five most relevant segments are: other food products, bakery and farinaceous products, preserved meat and meat products, dairy products and beverages.

3.1.5 LOCATION OF THE PLANTS

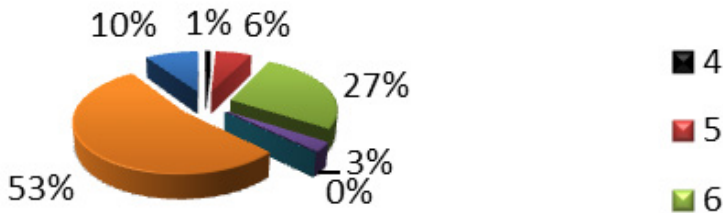

Figure 3.7 - % of industries per climatic zone

The climatic zones that should be considered are number 9, 10 and 6 in which the following countries are included: Spain, Italy, Portugal, Croatia, Bulgaria, Czech Republic, Germany, Estonia, Hungary, Austria, Poland, Switzerland, Greece and Cyprus.

3.1.6 EMISSIONS OF NH₃

The last analysis performed was the evaluation of the emissions of NH₃ in the selected countries in Europe where the five countries with the highest emissions are Germany, Spain, United Kingdom, France and Sweden, in 2009.

3.2 TECHNICAL INFORMATION ABOUT THE FOOD AND DRINK SECTOR

Options and aspects for the refrigeration vapour compression cycle deserve the most attention, since it is unlikely that during the next 10-20 years other principles will take over a substantial part of the market. In most of the application sectors, attention is focused on the vapour compression cycle. As stated, this cycle has thus far provided a simple, economic, efficient and reliable means of refrigeration (this includes cycles using ammonia, carbon dioxide, fluorochemicals and hydrocarbons as refrigerants).

HFCs have so far been important substitutes for CFCs and HCFCs. In many applications, alternatives to HCFCs have become commercially available, as pure HFCs, as blends of HFCs or as non-HFC alternatives.

In the long term perspective, there are five important refrigerant routes for the vapour compression cycle in all refrigeration and A/C sectors, listed alphabetically:

- ▶ Ammonia (R717);
- ▶ Carbon dioxide (R744);
- ▶ Hydrocarbons and blends (HCs, i.e. HC290, HC600a, HC1270 etc.);
- ▶ Hydro fluorocarbons with low GWP (HFCs/HFOs i.e. R1234yf, R1234ez and mixtures with these);
- ▶ Water (R718).

In the medium term perspective, the HFCs with higher GWP (i.e. R404A, R507, R410A) will be used. The pressure to phase down the consumption of HFCs will be related to their GWP and the leaks in the plants. A phase down of emissions has been adopted in the EU. There is a freeze of consumption 2015 based on CO₂ equivalent quotas based on the impact of each product. The pressure will thus first be focused on substances that have a very high GWP

such as R404A/R507, whereas e.g. R134a can be expected to be available longer. Alternatives with moderate and low GWP are being introduced to reduce the need for e.g. R404A/R507.)

Industrial systems are characterized primarily by the size of the equipment (physical size and heat transfer capability) and the temperature range covered by the sector. They are characterized by heat extraction rates in the range 10 kW to 10 MW, typically at evaporating temperatures from +20°C to -50°C.

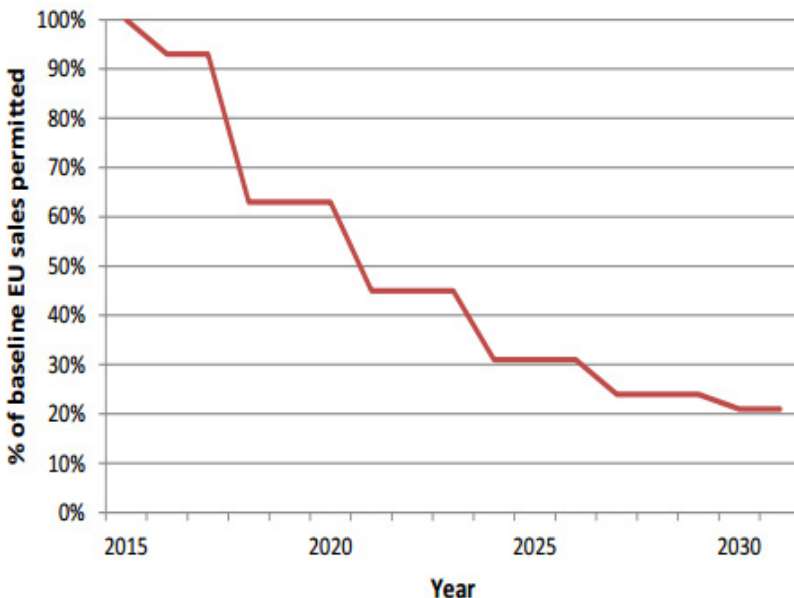

Figure 3.8 - EU Phase Down Profile

3.2.1 EVOLUTION OF THE INDUSTRIAL REFRIGERATION SYSTEM

The size of the industrial refrigeration market is difficult to assess because it covers such a broad range of applications.

Thirty years ago, chlorofluorocarbons were widely used in the industrial sector in many European countries, particularly blends, such as R502. The particular advantage of these substances was the low index of compression which allowed for single stage operation over a wider pressure ratio than could be achieved with R717 or even R22.

With increased emphasis on climate change in recent years, the importance of energy efficiency is now far greater than before. This has led to a reappraisal of previous policies, for example in the growing trend for central systems with R717 rather than multiple commercial systems with HCFCs. There is also a greater focus on system integration to make better use of waste heat recovery.

In Europe, regulation on the use of fluorinated gases has also encouraged users to consider R717 and other developments such as the use of R744 in cascade systems.

In the industrial sector it is likely that the adoption of R717 and R744 by users who previously deployed R22 and HFC blends will reduce the energy-related global warming potential through increased efficiency as well as through eliminating the direct global warming potential caused by refrigerant leakage.

3.2.2 REFRIGERATION SYSTEM AND TYPE OF REFRIGERANT

The technological options for air conditioning and refrigeration are expected to evolve over the next several years as designers continue to replace R22 with non-ODS (non-ozone depleting substances) alternatives and focus on developing lower GWP (Global Warming Potential) alternatives for e.g. R404A, R410A and R407C. There are several low and medium GWP alternatives being considered as replacements for R22. These include lower GWP HFC refrigerants (R32, R152a, R161 and the so called HFO such as R1234yf and other unsaturated fluorochemicals, as well as blends of them) and Hydrocarbons such as R290 and ammonia R744. R290 and some of the HFC refrigerants are flammable and will need to be applied in accordance with an appropriate safety standard such as IEC-60335-2-40, which establishes maximum charge levels and ventilation requirements.

Industrial systems are characterized primarily by the size of the equipment and the temperature range covered by the sector and R717 is the most common refrigerant in industrial systems, although with significant regional variations around the world. Where R717 is not acceptable for toxicity, flammability or cost reasons, R744 can be used, either in cascade with a lower charge R717 plant, in cascade with a fluorocarbon or rejecting heat direct to atmosphere in a high pressure (“transcritical”) system.

The environmental pressure and technical development of alternatives in industrial refrigeration is increasing the use of R717 and R744 in this sector.

A significant amount of research, development and testing is required before unsaturated HFCs can be deployed in large industrial systems, and their high refrigerant price will be an impediment to adoption.

In industrial refrigeration, R717 (ammonia) and R22 have been the most common refrigerants; R744 is gaining in low-temperature, cascaded systems where it primarily replaces R717, though the market volume is small. The pressure to phase out R22 due to EU regulations is resulting in a phase out. From January 1st 2015 there is a ban to recharge even with recycled R22.

R717 and HFC are the most common refrigerants for new equipment; cost considerations have driven small new systems to HFC use. R744 is gaining in low-temperature, cascaded systems where it primarily replaces R717, though the market volume is small for such systems.

Evaporative condenser manufacturers report that 90% of the condensers sold in Europe, Russia, India and China are for R717 systems. The rest are used on R22, R404A, R507A or occasionally R134a systems.

Smaller industrial systems more often use air-cooled condensers, and in these cases the refrigerant is more likely to be a fluorocarbon.

R22 was banned in new installations from 2010 onwards and recharge is not allowed from 2015 onwards within the EU.

R404A and R507A have been used for smaller low temperature systems and R134a for high temperature systems.

Users of HCFCs in smaller industrial systems are faced with the choice of whether to switch to HFCs, where a phase-down within equipment's life span can result in price increase and/or heavy taxes on the high GWP refrigerants like R404A/R507A, or to change to R717 or R744 and deal with the change in operating practices that those refrigerants would require. Lower GWP alternatives are being introduced but experience is limited (January 2015) and for some technologies such as flooded evaporators that are common in industrial plants special alternatives would be required and it is unclear if such alternatives will be available.

In EU-27, CO₂ eq emissions have decreased from 170 million tonnes in 1990 to 147 million tonnes in 2010 (Figure 3.10) despite more than a doubling of the refrigerant bank from 200,000 tonnes in 1990 to about 510,000 tonnes in 2010 (Figure 3.9) meaning an average market growth of 5% per annum. This is due to the accelerated phase-out of CFCs and HCFCs under the EU ODS Regulations and to the introduction of the EU F-Gas Regulation in 2006.

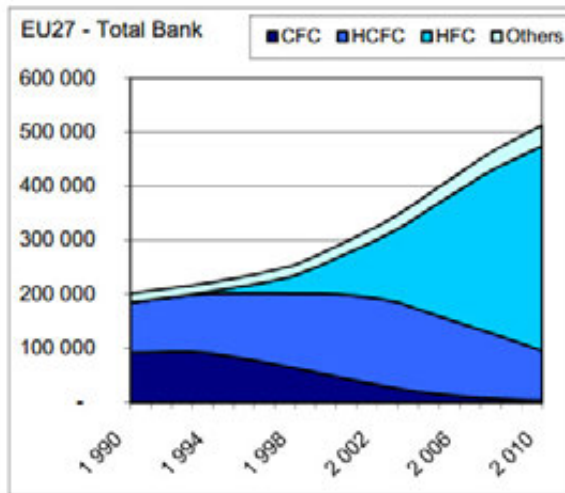

Figure 3.9 - EU Refrigerant bank from 1990 to 2010

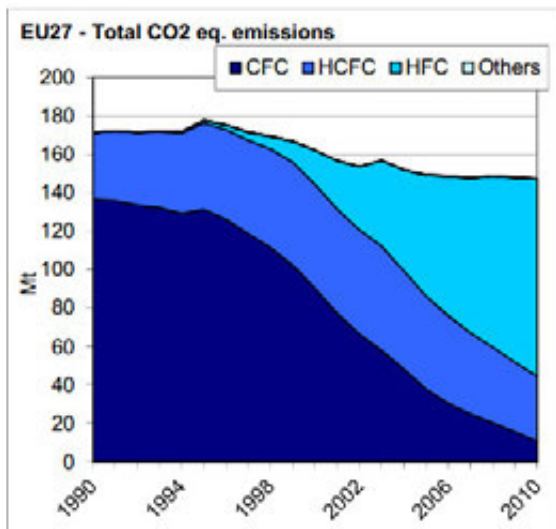

Figure 3.10 - EU CO₂ eq. refrigerant emissions

Under both scenarios, F-Gas and F-Gas Plus, the refrigerant bank increases between 2010 and 2030 from approx. 510,000 tonnes to between 800,000 (F-Gas plus - Figure 3.12) and 900,000 tonnes (F-Gas Figure 3.11) (+ 60% to +75%). This increase is due to economic growth forecasted to be 2% in EU-15 and 4% in EU-new, refrigerant conversions in existing installations as well as the increase of heat pump and air conditioning use which is contributing to the total CO₂ emission reduction. The additional 15% reduction for the F-Gas Plus scenario can be achieved due to more stringent efforts on containment, end of life recovery and refrigerant charge reduction.

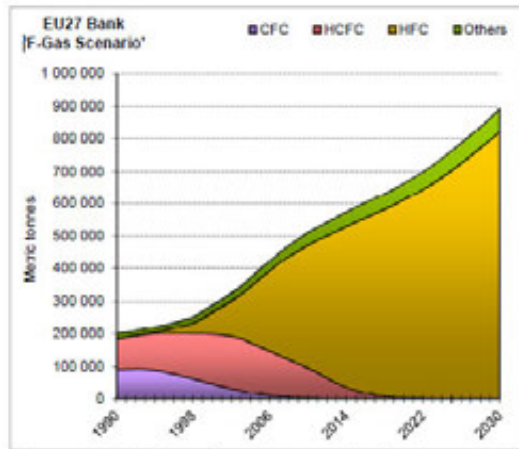

Figure 3.11 - Overall refrigerant banks from 1990 to 2030 F-Gas Scenario

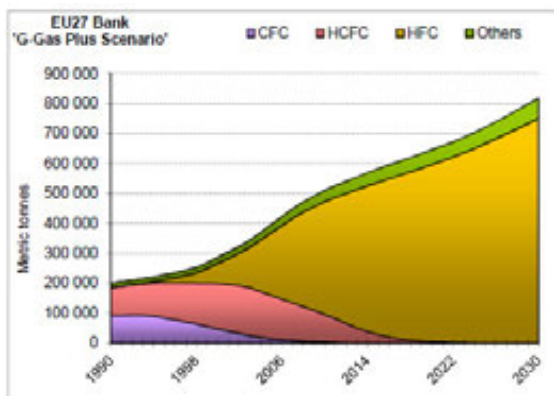

Figure 3.12 - Overall refrigerant banks from 1990 to 2030 F-Gas Plus Scenario

3.3 EFFECT OF COOLING PARAMETERS ON ENERGY CONSUMPTION

Within the COOL-SAVE project, energy audits were carried out in selected plants. From the energy audit reports on the plants, several parameters have been observed which affect the overall energy consumption.

3.3.1 PRODUCTION AND LOAD ON COMPRESSORS

The first key parameter that influences the performance of the plants is the cooling energy needed during production. This directly affects the load of the compressors. Depending on the compressor type, operating in partial load or operating with frequently varied load could affect the COP and thus the performance of the system.

If production is variable, the load on the compressors will change and this will affect the performance of the system, depending on the installed compressors and the control strategy used.

Furthermore, the capacity of the system will affect the temperature difference on the secondary media, which in turn will influence the condensing and evaporating temperatures. Large temperature differences on the warm secondary media will raise the condensing temperature, thus decreasing the COP and the performance of the system.

3.3.2 INSTALLED EQUIPMENT

The second key parameter that affects energy consumption is the installed equipment. The type of the installed compressors, the evaporator and the condenser will all influence the performance of the system.

A performance analysis of the refrigeration system determines the isentropic compressor efficiency, which is an indicator of how the compressor is affecting the performance of the system. Low compressor efficiency can be caused by partial load operation or by a damaged compressor.

The system performance will also be influenced by the equipment installed on the secondary media. The non-optimal flow of the condenser fans will cause high condensing temperatures which in turn will increase energy consumption.

3.3.3 CONTROL STRATEGY

The control systems used do not have an effective adaptation to working conditions and do not aim to optimize energy consumption.

An example of a non-optimal control strategy is to use more than 1 compressor to provide the base cooling load. Providing the predominant load with only 1 compressor would increase the isentropic efficiency of the compressor, adjust the temperature difference on the secondary media, and thus improve the general performance.

An energy efficient control strategy would be to start operating the reciprocating compressor with low cooling demands and increase its load when the cooling demand increases. When the reciprocating compressor is operating at full load but there is more cooling demand, the screw compressor would start operating, thus taking the load from the reciprocating compressor and operating efficiently at full load. If the cooling demand further increases, the reciprocating compressor would start operating and increase its load as the cooling demand increases.

This control strategy would ensure the operation of the screw compressors at full load, where they are most efficient.

3.3.4 GEOGRAPHICAL LOCATION

A key parameter affecting the energy consumption of a system is the geographical location of the plant.

The temperature and humidity of the ambient air play an important role on the capacity of dissipating the plant's heat, and thus in the performance of the plant. High ambient temperatures will lead to higher condensing temperatures, which decreases the overall performance of the system and forces to use higher electrical power. Low ambient temperatures allow the system to have lower condensing temperatures which improves the COP, thus reducing power usage.

A positive correlation can be observed between the power used and the ambient temperature. As the temperature increases, it becomes more difficult for the system to release heat, thus decreasing its performance and increasing the power needed.

For an evaporating temperature of -10°C , a change of 15 degrees from 15°C to 30°C can increase the power needed from the system by 50%.

3.4 CONCLUSIONS

Industrial refrigeration plants are mainly based on refrigeration the vapor compression cycle.

The main refrigerants used are as follows:

- ▶ Ammonia (R717)
- ▶ CO₂ (R744)
- ▶ HCs and blends
- ▶ HCFCs
- ▶ Water (R718)

Since the Montreal protocol in 1994, CFC and HCFC refrigerants must be replaced by other non-ODS refrigerants. The main refrigerants used today are as listed:

- ▶ Ammonia (R717)
- ▶ HFCs
- ▶ CO₂ (R144) for low temperature in cascade systems with ammonia.

Ammonia is the most used refrigerant in new equipment in large industrial systems. R22 is the most used refrigerant in small systems.

Specifically, in the food and drink sector, ammonia is the main refrigerant in new installations.

Relative to energy consumption, the ratio of cooling demand per ton of product is highest in the meat and fish industries (43,5 W/t).

Companies which produce frozen food have a ratio of 35,8 W/t in cooling plants. These three activities are those with the highest demand of energy in cooling plants.

In the drinks sector, energy consumptions varies depending on the type of beverages. Wine and beer production nearly doubles the need for cooling compared to soft drink industries (17,3 W/t against 9,5 W/t).

Every year, over 40% of the total energy consumed in Europe is used for the generation of heat for either domestic or industrial purposes whereas cooling demand is growing exponentially. The importance of the heat and cooling sector is underlined in EU energy policy initiatives. This emphasizes the role of technologies based on renewable energy sources combined with high-efficiency

energy technologies, to meet the heat and cooling demand in Europe more sustainably in the future. Against this backdrop, it is essential to identify the current and future heating and cooling demand and the technologies employed in the domestic, commercial and industrial sectors in the EU.

Cooling is used at different levels in food and drink industry processes. Two thermal levels, positive or negative cooling are at stake.

- ▶ Freezing
- ▶ Lyophilization (baby food, ready meals, powders...)
- ▶ Texturing and formulation (chocolate, butter fat, cheese, dairy desserts, ice cream...)
- ▶ Cryoconcentration – cryoseparation (juice, grape musts, tartaric acid (white, champagne))
- ▶ Fermentation control (wine, beer, champagne)

The cooling demand will increase between 10% and 20% in the next decade, even without considering demographic growth and rapid urbanization. Moreover, to comply with regulation resulting from the Montreal and Kyoto protocols, we are witnessing the emergence of new cooling technologies in the food and drink industry. For instance, “alternatives” cycles are being developed, such as $\text{NH}_3\text{-CO}_2$ or cascading technologies.

There is growing awareness for the need to decrease the energy consumption of cooling systems, as cooling demand and energy prices are rising. From a consumer point of view, the necessity is to decrease, if not the consumption, at least the energy bill. From a producer point of view, the necessity is to align demand with production.

COOLSAVE

Development and dissemination of cost-effective strategies to improve energy-efficiency in cooling systems in the food and drink sector

COOL-SAVE is an **innovative project** which aims at **reducing industrial energy consumption in cooling installations** by vapor-compression mechanical system in the food and drink sector, through the dissemination of **cost-effective energy-efficiency strategies implementation**.

The main objective; to **optimize the vapor-compression mechanical systems** in the food and drink sector.

New Refrigeration plant energy-efficiency diagnostic webtool

- Calculate estimated potential energy savings
- Develop a customized improvement strategy

Sign up online at cool-save.eu/webtool



Have your say!

Are you a refrigeration professional?

Do you have something to say about energy savings in commercial refrigeration applications?

Take the **COOL-SAVE survey today** at cool-save.eu

Get involved in one of the leading European projects on energy saving strategies for cooling systems.

Before getting started, why not view the presentation on *"Economic and technical feasibility of generic energy efficiency optimization solutions."*

BASELINE DATA FOR EVALUATION OF ENERGY CONSUMPTION

Evaluating the cost effectiveness of measures in an industrial refrigeration plant is a challenge as energy consumption is distributed over several “consumers” and affected by many factors that vary over time in ways which are difficult to predict. The complexity of the plants and variations in consumption create a lack of easy-to-use benchmarking parameters, resulting in the phenomenon that only one focus has often been prevailing – to keep the temperatures at desired levels. The lack of detailed historical performance and energy consumption data creates a major challenge when energy optimisation is discussed.

When the current performance and dependency on external parameters are unknown, the cost effectiveness of any improvements is impossible to calculate and returns of investments are uncertain.

Knowledge of installed equipment and its design data is insufficient to evaluate operating performance as no plant operates at design conditions over extended periods of time. The energy consumption of a refrigeration plant can in general terms be said to vary according to five main factors:

- ▶ The load created by the production and storage requirements
- ▶ Heat absorption/undesired ventilation in supply lines, production systems and storages
- ▶ The required temperature levels on the process side
- ▶ Heat rejection temperature level, which is a result of the ambient temperature or in case of water cooled systems, the supply water temperature and availability. In cases with heat recovery, the heat rejection temperature can be optimised to a different level.
- ▶ **The performance of the refrigeration system**

When the energy consumption of refrigeration is evaluated it is also obvious that the potential for heat recovery and to what extent it is used should be included in the evaluation. To achieve an energy-efficient plant, all these factors need to be evaluated individually and consideration should be taken so as to

the way they interact. Design for worst case and rules of thumb are commonly used for setting up systems, which then often remain set as at start-up if they do not cause apparent problems - despite resulting in high energy consumption.

“**Measuring is knowing**” and the first step in any optimisation project must be to gather available historical data and identify what additional parameters must be measured as a part of the optimisation project to get proper information, to make correct decision as well as validating the impact of implemented measures.

4.1 REQUIRED ENERGY INFORMATION FOR EVALUATION OF OPTIMISATION PROJECTS

To execute a meaningful energy optimisation project the following information is essential.

- ▶ Description of production and temperature requirement
 - ▶ Known data on design loads for production and storage
 - ▶ Operating pattern, operating hours, batch production or continuous
 - ▶ Lay-out of plant with location of loads
 - ▶ Flow chart of refrigeration systems
- ▶ Location - climate conditions
- ▶ Inventory of installed energy consuming product models, sizes and ages
 - ▶ Compressors
 - ▶ Fans
 - ▶ Pumps
 - ▶ De-frost
 - ▶ Other major users
- ▶ Planned future changes in production
- ▶ Historical energy consumption
- ▶ History of plant – redesigns – problems

4.2 CLIMATE INFORMATION

As the energy consumption in almost every plant is strongly affected by the ambient conditions it is important to correlate performance to the ambient temperature (and sometimes relative humidity). Climate data is available from several sources for virtually any location. It is preferred to have data for a typical/normal year as bases for evaluation rather than using e.g. the last year as a reference. In most cases average temperatures per hour over the normal year is sufficient resolution for evaluation. As the impact of many measures vary with temperature a graph like the one below allow saving potential of recommended measures to be evaluated. If plant operations vary over the day, week or year it can be necessary to create several of these graphs to cover a year, e.g. one for night and one for work day time if the plant only operates one eight-hour shift.

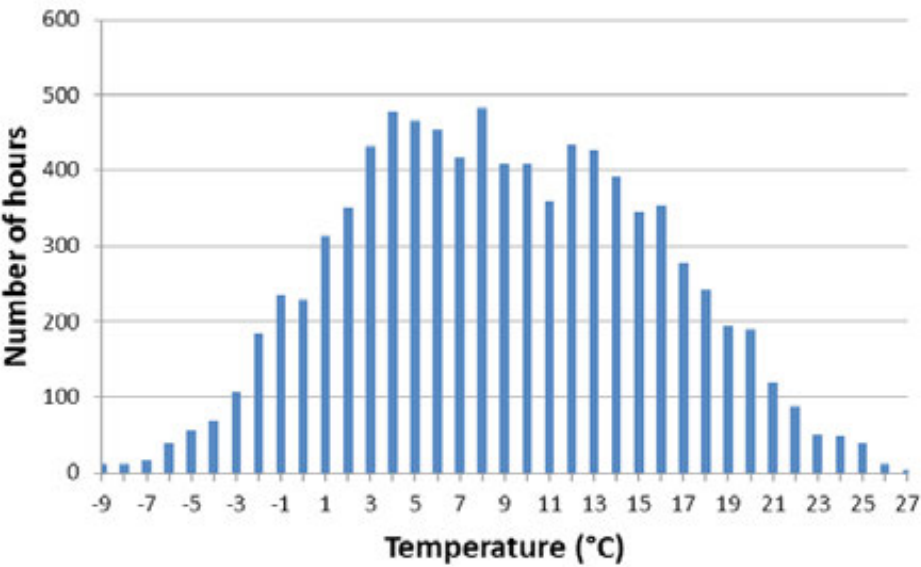

Figure 4.1 - Climate information

4.3 ENERGY AND POWER PROFILE

The most effective ways of evaluating and following a refrigeration plant is to monitor the electrical energy consumption per hour in relation to ambient temperature. This creates a pattern that normally creates a predictable “profile” that is a base to follow the efficiency and quantify impact of optimisation measures and also useful to detect if measures are successful and if an achieved improvement is sustained over time.

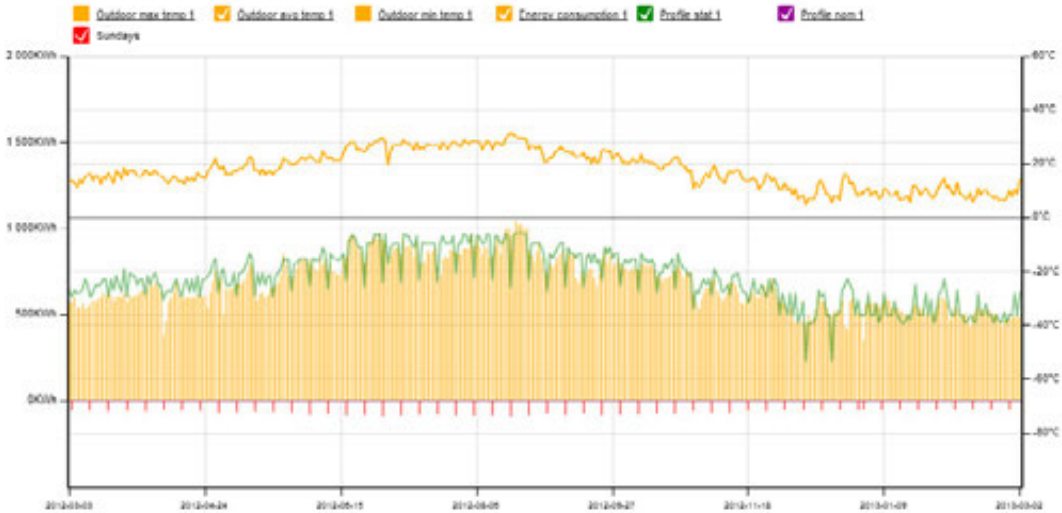

Figure 4.2 - Energy consumption per hour

yellow: outdoor temperature/green line: statistical consumption

The green line in Figure 4.2 is generated from the statistical data of average kWh/hour at the ambient temperature. In the example, the weekends are showing clearly lower energy consumption. The statistical data at each ambient temperature will build up a “power profile” that is useful to predict the expected consumption after measures.

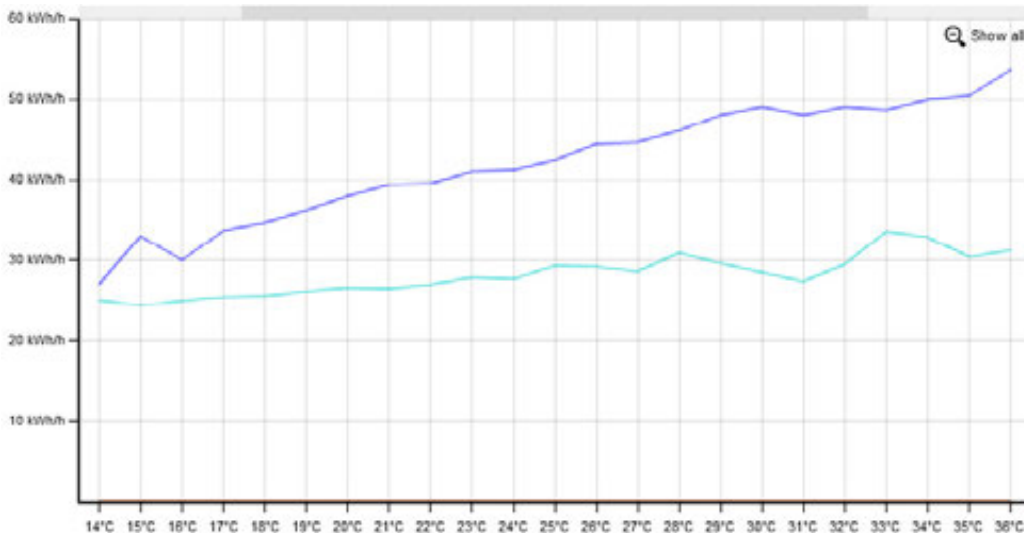

Figure 4.3 - “Power profile” top line during high production hour and lower during low production hours

Any improvement or decrease of performance will show up as a deviation versus the “Power Profile”. This is a very powerful tool in the optimisation work. Depending on the available measurements, the power profile can be evaluated as compressor power only or including auxiliary loads. The main advantage of the energy and power profile is that they make it possible to continuously monitor the optimisation work on a plant and evaluate the results on measures taken on plants that are often dynamic plants where it can be very challenging to find comparable “conditions” to identify before and after.

4.4 ANNUAL ENERGY CONSUMPTION BASED ON THE POWER PROFILE

By providing a power profile for a refrigeration system and the use this together with local climate data, for a “ordinary” year, e.g. how many hours per year each temperature occur the saving of different measures can be estimated. Some measures will have impacts over ambient temperatures whereas many others will have impact only at some conditions. The changes in energy consumption over time are the bases for calculation of the cost-effectiveness of different measures.

4.5 ANALYSING THE PERFORMANCE OF THE REFRIGERATION PROCESS

The component and energy information identified as required above cannot be used alone as a basis for energy efficiency as they do not give input on how installed equipment works. The plant design information can in the best case give information on how the plant is intended to work but it is very rare that a plant works as designed. The next step is then to measure how the plant actually works to identify optimisation potential in the refrigeration systems. A systematic evaluation of the performance of each part of the refrigeration process is required. The bases for these evaluations are measurements used for a thermodynamic evaluation of the process. Also measurements on secondary systems can when available contribute to evaluation.

4.6 COEFFICIENT OF PERFORMANCE - COP AS A PERFORMANCE INDICATOR

The traditional performance indicator for refrigeration processes is the COP which is a very important tool but has the disadvantage of being totally dependent on the operating conditions and thus challenging to use for benchmarking between plants and to communicate to non-experts. But as a tool to work with optimisation it is one of the most important factors to identify performance of the plant and identify where optimisation potential exists. The COP of the system at different representative operating conditions should be documented.

Measured COP can be compared with manufacturer performance data on system as well as compressor levels. The COP can be evaluated excluding auxiliary loads data and as system COP including auxiliary loads data. What is included should always be specified when the COP is discussed.

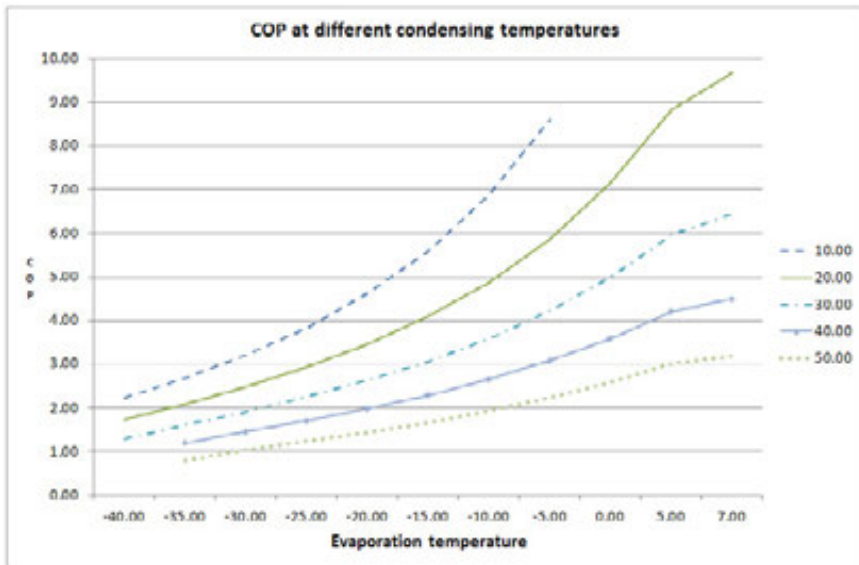

Figure 4.4 - COP variation of a good reciprocating compressor

The COP is a parameter that due to the dependency of operating conditions must be related to a specific operating condition to make sense. Due to the continuous variation of operating conditions the COP is a comparator with strong limitation when optimising dynamic plants in normal operation. It is also essential to ensure that system boundaries are clearly specified before any comparisons are done between plants or with design.

4.7 SYSTEM EFFICIENCY INDEX - SEI AS A PERFORMANCE INDICATOR

The System Efficiency Index - SEI is a parameter that has recently attracted a lot of interest as it compares design or measured data with a 100% efficient process as it does not have the same dependence on the operating conditions (SP report 2014). The 100% efficient process is defined as the “Carnot process” but instead of the traditional way of applying evaporation and condensing temperature, the evaluation is based on reference temperatures that for example on the cold side is the required supply temperature to a process or a storage temperature and on the warm side the ambient temperature. The SEI can also be defined for the refrigeration process as such or by including the auxiliary

within the system boundary in the COP making it a SCOP for to compare COP with system boundaries with Carnot COP based on the reference temperatures for that system.

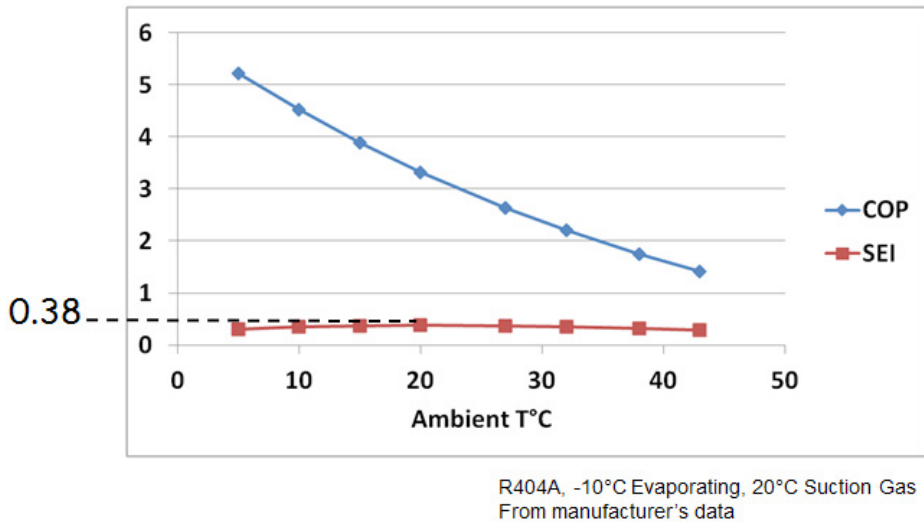

Figure 4.5 - Example of how SEI is an indicator much less sensitive to ambient condition than COP

The SEI will show the performance relative to a 100% efficient process, but it will also be possible to identify where in the system efficiency is lost by calculating the sub-efficiencies. Typically the relevant sub efficiencies are:

- ▶ Cycle efficiency - showing the influence of the selected process and refrigerant
- ▶ Compressor efficiency – deviation from an ideal process; this should be evaluated at full and part load
- ▶ Condenser efficiency - deviation from an ideal condenser without pressure and temperature differences
- ▶ Evaporator efficiency - deviation from an ideal evaporator without pressure and temperature differences

An example of visualisation of total SEI as well as sub-efficiencies of a high efficiency 350 kW ammonia chiller is shown in figure below. This chiller reaches over 50% of the theoretically possible, which is near the state of the art today.



Figure 4.6 - SEI and Sub efficiencies can be visualised and impact of pumps and fans can also be expressed as efficiencies to benchmark performance on a component level and high light where measures are justified.

4.8 REQUIRED MEASUREMENTS FOR PERFORMANCE ANALYSES

To carry out a thermodynamic evaluation of a plant is not as challenging today as it has traditionally been considered. Some control and monitoring systems have sufficient data to allow an expert to do the evaluation. If existing BMS/SCADA systems are used it is important to ensure that all inputs required are available with good accuracy, sampling frequency is acceptable and all used values are collected at the same instant. When the BMS/SCADA system does not contain all required data non-intrusive “Performance analysers” can be hooked up to an operating refrigeration plant to register dynamic performance in real time. This can prove to be a cost-effective way to get the required information. The equipment can be used for a shorter measurement, establishing performance under a given condition but for optimisation of an industrial plant, it is often necessary to measure over some time with varying climate conditions, and permanently installed performance analysers offer further benefits during the whole optimisation process and to ensure that achieved optimisation is sustained in the future.

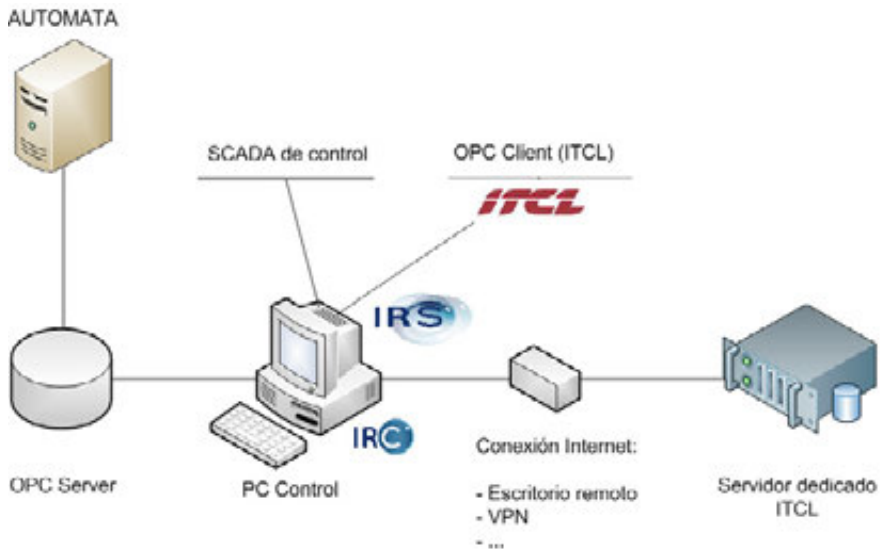

Figure 4.7 - Examples of portable and permanently installed equipment for data collection for thermodynamic evaluation

It is recommended to have baseline data for at least one month with varying temperature conditions. Typically spring and fall give a wider range of conditions in a shorter period than summer and winter. With or without such tools the information required for the required thermodynamic analyses require a number of measuring points to be logged for each refrigeration process. The data points required need to be defined by an expert with knowledge on the actual plant in question, but the picture below shows an example for an ammonia chiller with heat recovery. The yellow boxes with black frames show measured values and the rest are data from the thermodynamic analyses of the system.

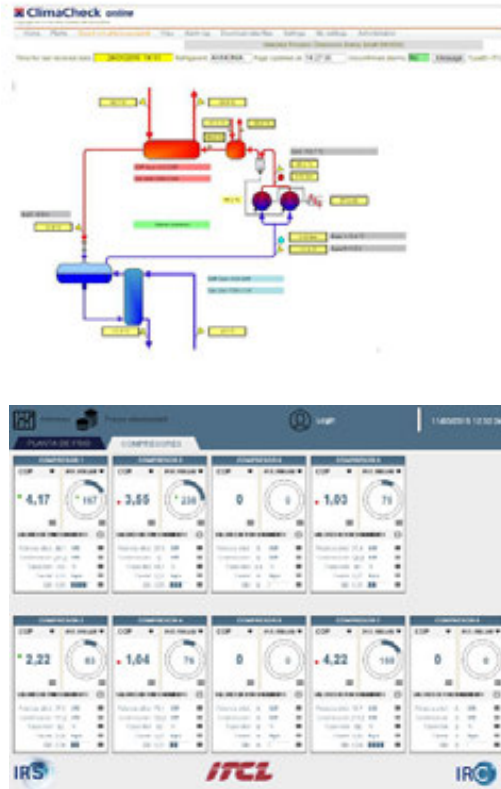

Figure 4.8 - Measuring points and result from thermodynamic analyses

Required data for performance of a single stage refrigeration process are:

- ▶ 2 pressures
- ▶ 7 temperatures
- ▶ Active power input to compressors

As fans and pumps often have a significant impact on the system performance it is important to measure also power to auxiliary loads. Experience shows that data sampling every minute gives a good resolution of data. When trouble shooting for specific problems, it can sometimes be cost-effective to increase sampling rates. Lower sampling rates are not recommended as changes in operation can then be missed, causing difficulties in understanding if the system is stable or unstable.

COOLSAVE

Development and dissemination of cost-effective strategies to improve energy-efficiency in cooling systems in the food and drink sector

COOL-SAVE is an **innovative project** which aims at **reducing industrial energy consumption in cooling installations** by vapor-compression mechanical system in the food and drink sector, through the dissemination of **cost-effective energy-efficiency strategies implementation**.

The main objective; to **optimize the vapor-compression mechanical systems** in the food and drink sector.

New Refrigeration plant energy-efficiency diagnostic webtool

- Calculate estimated potential energy savings
- Develop a customized improvement strategy

Sign up online at cool-save.eu/webtool



Have your say!

Are you a refrigeration professional?

Do you have something to say about energy savings in commercial refrigeration applications?

Take the **COOL-SAVE survey today** at cool-save.eu

Get involved in one of the leading European projects on energy saving strategies for cooling systems.

Before getting started, why not view the presentation on *"Economic and technical feasibility of generic energy efficiency optimization solutions."*

INVENTORY OF BEST ENERGY SAVING STRATEGIES

When baseline performance is established over a sufficient variation of conditions and loads the process of evaluating measures start. This should be done in a systematic way as all measures interact in a refrigeration process. It is obviously not ideal to focus on partial load performance and control until potential for load reduction has been considered. All changes in the control strategy need to take other planned measures into account. Many times it is most cost-effective to have a step-by-step approach as it can be difficult to evaluate the end result of the number of smaller and bigger measures that are often identified as cost-effective. The final tuning of control should always be done as the second-last step. The last step should always be validation of the performance at different loads and conditions to ensure efficiency and reliability.

After the different measurements were carried out in the selected plants the technical partners of the project suggested energy saving solutions for the plants. This chapter explains those energy saving solutions which were identified as the most relevant generic solutions for the food and drink industry, based on the measurements carried out in the framework of the project (WP2, WP3) in light of the economic and technical feasibility. The major areas for optimization are listed in the recommended order for evaluation. The recommended order of evaluation is based on the fact that 1-7 will affect the load for the compressor and this in turn will impact the control strategies that need to take all the other measures into consideration.

5.1 LOAD REDUCTION

5.1.1 OBJECTIVE

Decrease energy consumption by reducing refrigeration needs in cooling and freezing chambers and in product lines.

5.1.2 TECHNICAL DESCRIPTION

In a production facility, high energy consumption can be a positive sign of an increase of sales or production, even if energy savings are obviously not intended to decrease production. Many operations are one-sidedly focused on production and sometimes an approach of “do not fix something that is not broken” surfaces when “improvements” to decrease energy consumption are discussed. As decreased energy consumption will have direct results on the profitability, it is important to minimize kWh/production unit. Whereas kWh/production unit might be important from competitiveness aspects, it is often a difficult parameter in energy optimisation projects, due to the fact that most plants are working with multiple products and in many cases with batch production with varying influence on energy consumption.

The first step in any optimisation strategy should be to evaluate the use of cooling to ensure that a system is not optimised for a higher load than required. This report is not focused on this area as there would be limited possibilities to generalise these conclusions and they are not related to the refrigeration performance as such. But it can be concluded that there are often significant possibilities to reduce the load for the refrigeration plant by ensuring:

- ▶ Proper insulation in cold rooms/areas – roof, walls, floor
- ▶ Ventilation which is adapted to the needs, to avoid heat losses and moisture load
- ▶ Proper air conditioning and dehumidification in preparation and loading areas to reduce load from heat transfer and moisture migration to cold areas/surfaces
- ▶ Efficient handling of raw materials and products to reduce cooling down requirement in processes and storage i.e. precooling of products

5.1.3 TECHNICAL REQUIREMENTS AND RECOMMENDATIONS

To improve and reduce cooling and freezing demand it is necessary to conduct a detailed study of the infrastructure used by the final users of the refrigeration demand.

The technical experts should analyse opportunities to improve rooms, freezing tunnels and other equipment with refrigeration demand. This analysis should include an evaluation of where the biggest improvements are possible in order to prepare an investment plan.

5.1.4 ENERGY SAVING POTENTIAL

Due to the choice of focus of the COOL-SAVE project, there is no data available on improvement of energy efficiency by reducing cooling and refrigeration loads that are very dependent on the product and production line. The COOL-SAVE project has focused its efforts on analyzing cooling and refrigeration production.

5.1.5 IMPLEMENTATION COST AND RETURN ON INVESTMENT

Due to the main focus of the COOL-SAVE project there is no data available of investment costs relative to measures to reduce cooling and refrigeration loads. The COOL-SAVE project has focused efforts on analyzing cooling and refrigeration production.

5.2 REDUCTION OF HEAT LOSSES AND PRESSURE DROPS IN REFRIGERATION SYSTEM

5.2.1 OBJECTIVE

Improve energy efficiency of the refrigeration plant by reducing or eliminating energy loss due to heat loss and pressure drops in the refrigeration system.

5.2.2 TECHNICAL DESCRIPTION

In many food and drink companies, losses registered because of heat absorption in supply lines and/or pressure drops in refrigeration suction lines are considerable.

- ▶ Insulation of all cold pipes, surfaces and components should be kept in good shape and checked for moisture ingress that can influence effectiveness of isolation. With age, it is common that insulation loses efficiency and absorbs moisture.
- ▶ Pressure drops in refrigeration suction lines should be checked to identify if valves, components or pipes have to be changed.

5.2.2.1 Reducing “cooling losses” from tubing and components

All surfaces in a refrigeration system that are cooler than the surroundings will result in loss of cooling capacity. Heat leakage into the suction line will also increase the required power to compress the gas and increase the operating temperature of the compressors. As a plant ages, the insulation on cold surfaces will normally lose its insulation properties due to age, but also as moisture can

accumulate in insulation and/or where insulation is damaged. Moisture or ice in insulation will result in increased energy consumption but also risk for corrosion and mechanical damage with ice melting and freezing.

Repairing any important weak point in the pipe system thermal insulation

Heat exchangers on the cold side suction lines, flash economizer (intercooler), inter-stage lines and certain other refrigerant lines have cold surface temperatures which should be insulated to avoid loss of cooling and condensation of water. Otherwise this extra heat load increases the cooling demand and power consumption of the plant without benefit for applications.

Insulation ensures that most of the cooling capacity is reserved for the applications. Selected technical options are generally as follows:

- ▶ No insulation of the pipes HP (liquid and discharge lines) unless there is a desire to reduce heat emissions to the area where the pipes are located. Heat losses on warm side is only negative for efficiency if the heat would otherwise be recovered.
- ▶ Insulation of pipes on the cold side (suction and low pressure distribution lines in pumped systems)

The insulation of the pipes must follow different criteria:

- ▶ Sufficient reduction of heat transfer
- ▶ No condensation and minimum corrosion.
- ▶ Financially acceptable investment

Inadequate thickness of insulation or deterioration of existing insulation

- ▶ Increase heat transmission
- ▶ Increase the risk of water condensation (→ loss of vapour barrier)
- ▶ Corrosion can occur (→ electrolysis with water condensation)

Financially, the simplest method to choose economical insulation is by comparing the cost of energy losses with the cost of insulating the pipe. Suppliers today offer superior insulating materials (type/ thickness) at reasonable prices which have made retrofitting or re-insulation an attractive energy saving option. However, the installation of components such as valves increases the labour cost in the total cost.

Factors to consider:

- ▶ Insulation material
 - ▶ thermal insulating sleeve (glued to the tubes)
 - ▶ thermal insulating shells (glued to the tubes)
 - ▶ in situ injection of insulation (large diameter tube)
- ▶ Vapour barrier type
 - ▶ plastic material
 - ▶ steel sheet
 - ▶ aluminum sheet
- ▶ Support structures to avoid thermal bridge and condensation

5.2.2.2 Reducing pressure drop: replacing valves and components with costly pressure drops

Pressure drops in valves and other components especially on the suction side can be costly due to the impact of pressure drop on compressor performance. A pressure drop corresponding to 1°C evaporation can have a cost of 3-5% higher energy consumption. In the liquid line, pressure drops can cause inefficient operation as the flash gas generated causes difficulties to control refrigerant flow to evaporators. Liquid line pressure drops often occur not only in tubes but also in filters, solenoid-, check- or shut-off valves. Problems in control of flow through expansion valves, caused by pressure drops, are often corrected by increasing the condensing pressure. A higher condensing generates subcooling through heat rejection to surroundings but will also cost a significant amount of energy.

5.2.2.2.1 Resizing pipe systems

Good piping design results in a balance between the variations of the refrigeration system application, the pressure drop and initial cost. The energy cost is impacted by the diameter and the layout of the piping. As refrigerant flows through pipes, the pressure drops in the piping must be minimized to avoid adversely affecting performance and capacity of refrigeration plant. In most cases, maintaining a sufficient speed is necessary for the proper oil return to the compressors.

SUCTION LINE

Suction gas lines allow refrigerant gas from the evaporator to flow into the inlet of the compressor. A velocity of gas refrigerant is recommended between 12 and 30 m/s.

1) Good sizing

a) An undersized suction line reduces compressor capacity by forcing it to operate at a lower suction pressure to maintain the desired evaporator temperature. Decreased pressure affects compressor performance (increases compression ratio and electrical consumption).

b) Oversizing the suction line increases initial costs and may result in insufficient refrigerant gas velocity to move oil from the evaporator to the compressor. This is particularly important when vertical suction pipes are used.

c) The piping should be designed to avoid refrigerant vapour and oil from flowing back into the compressors. In the case of ammonia NH_3 , suction lines should present a downward slope of 1% in the direction of refrigerant flow, generally inverted trap or check are installed before compression units.

5.2.2.2.2 Suction electronic regulator

Solenoid valves with position adjustment are used as control valves. The electronic control allows for cooling based on need. With a fairly low load, the valve closes and the evaporation temperature increases. To cool the compressor, it is necessary to install a bypass on the valve on the suction side of compressor, the pressure drops. The power absorbed by the compressor decreases. Calculated on power absorbed at minimum allowable suction pressure, for partial charges **the energy savings can reach 30 %**.

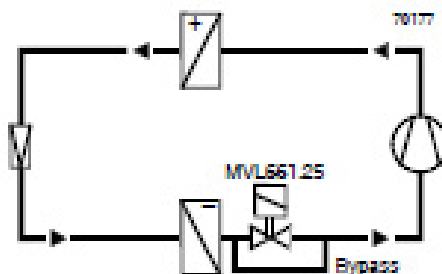

Figure 5.1 - Electronic Suction regulator

5.2.2.2.3 Evaporator pressure regulator

With a fairly low load, the suction pressure will decrease, causing a decrease evaporation temperature. A pressure regulator is then introduced between the evaporator and the compressor, and creates a pressure drop.

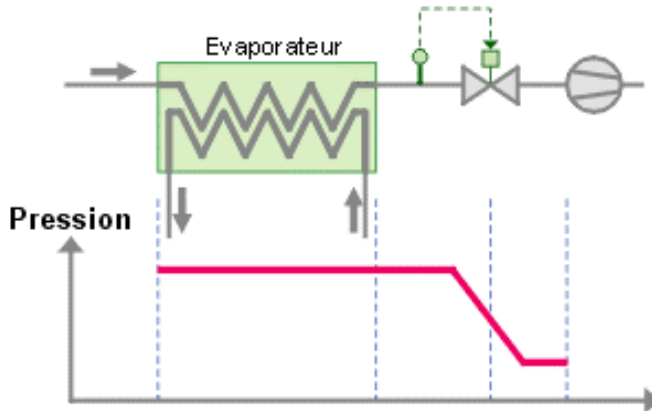

Figure 5.2 - Evaporator pressure regulator

The cooling capacity will decrease, but temperature in the compressor output will rise. The pressure regulator prevents evaporation against the risk of frost from the evaporator. Yet this regulation is frequently used when the power reduction does not exceed 40-50%. **However the efficiency of the machine is decreasing and alternative methods of capacity control are much more efficient.**

It is common to hear pressure drop referred to as degrees pressure drop or as kPa/Bar (for each refrigerant a pressure drop in kPa can be converted to degrees). Proper refrigeration system design attempts to minimize this change. Typical design is to achieve less than 1.2°K per equivalent 30 m line (pipe + components). For example, if a process requires 87.9 kW at 8°C a condensing unit must produce 87.9 kW of cooling at 7°C saturated suction temperature. Assuming a 1°C line loss, the compressor would have to be sized to deliver 87.9 kW cooling at 7°C saturated suction temperature e.g. a bigger compressor and a higher energy consumption.

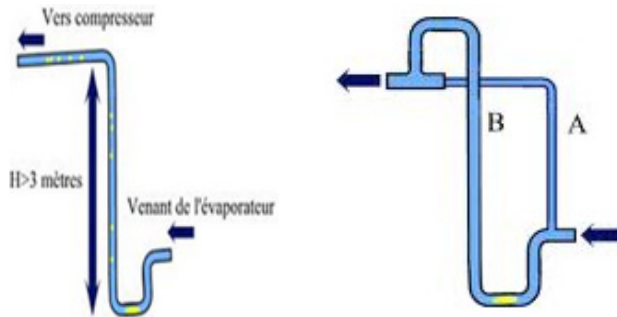

Figure 5.3 - Cooling power variable, tall pipes

5.2.2.2.4 Discharge line

Discharge gas lines (often referred to as hot gas lines) allow refrigerant to flow from the discharge of the compressor to the inlet of the condenser. They carry both refrigerant vapour and oil (majority trapped in oil separator). A velocity of gas refrigerant is recommended between 10 and 20 m/s.

1) Good sizing

- a) An undersized discharge line increases pressure HP which reduces compressor capacity (increasing compression ratio and electrical consumption).
- b) Oversizing discharge lines may result in insufficient refrigerant gas velocity to carry oil (non-trapped) back to the compressors.
- c) The piping should be designed to avoid liquid refrigerant and oil from flowing back into the compressor. In the case of ammonia NH_3 , discharge lines should have a slope of 1% in the direction of refrigerant flow. Generally siphon trap or check valve are installed at the condenser inlet.

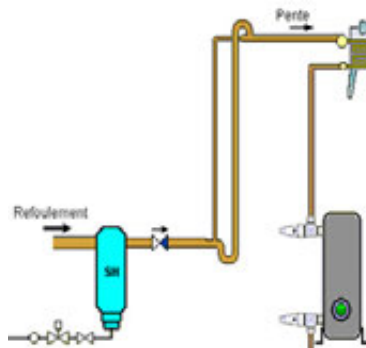

Figure 5.4 - Siphon trap

It is common to hear pressure drop referred to as °K (°K depending of refrigerant) versus PSI (kPa). Proper refrigeration system design attempts to minimize this change to less than 1.0°K per equivalent 30 m line (pipe + bends + components).

5.2.2.2.5 Liquid lines

Liquid lines allow refrigerant liquid from the condensing system to flow into the inlet of receivers (or tanks) before feeding an expansion valve system. A velocity of liquid refrigerant is recommended between 0.5 and 1.0 m/s.

1) Good sizing

a) An undersized liquid line causes a pressure drop, causing a “flash” of the liquid refrigerant. In this case, expansion valves and evaporators are fed by a “liquid +gas” mixture, causing a decrease in cooling capacity. The refrigeration system will operate poorly.

b) Oversizing liquid lines is discouraged because it will significantly increase the system refrigerant charge and, in turn, affects the oil charge. However, if the liquid pipes are ascending, it is recommended to oversize these.

c) The piping should be designed to avoid a “flash” of liquid refrigerant (feeding expansion valves) and gas traps. Liquid lines must present uniformly upward slope in the direction of refrigerant flow. If the piping length is large, sub cooling is needed (maximum 15°K).

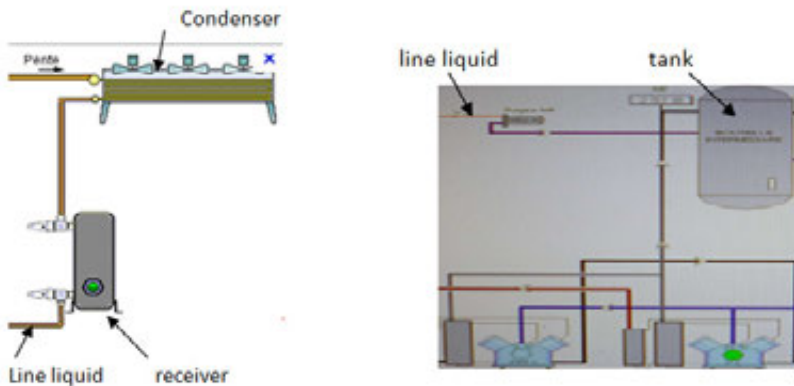

Figure 5.5 - Liquid line

5.2.2.2.6 Pipe installation in a pump circulation system

Piping “feed”

The pumping pressure is higher than that corresponding to the refrigerant temperature. There will be no “flash” and no appearance of bubbles. Easy installation and no negative impact on performance. A refrigerant velocity between 0.3 and 0.5 m/s is recommended. Maintaining a high degree of insulation of pipes is necessary.

Piping “return”

Pipe “return” circulates a “liquid + vapour” mixture to a separating vessel. It must be set up sloping towards the separating vessel. If the evaporators are arranged at a lower level the pipe “return”, provide an inverted siphon. Maintaining a high insulation of pipes is necessary.

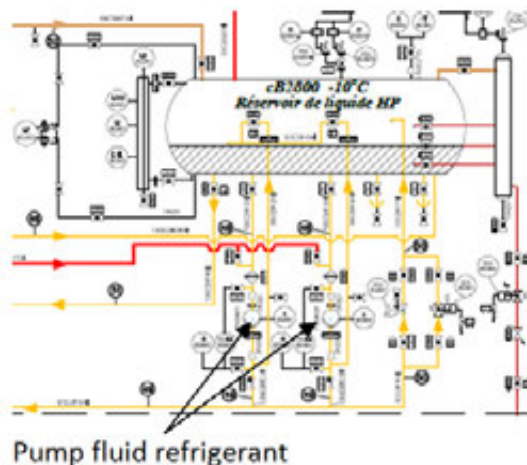

Figure 5.6 - Pump fluid refrigerant

5.2.2.2.7 Installation of electronic valves after studying the existing expansion device

Many mechanical refrigeration plants use expansion valves to obtain the minimum evaporation superheat by adjusting the flow of liquid in the exchanger (optimization of the cooling capacity), according to the rise in temperature and pressure evaporation.

Electronic valves often give better control compared to analogue technology, improving the COP and the compression ratio (resulting in energy savings).

Valves are often integrated with the chiller control system and are located after the condenser/HP liquid receiver and before the evaporator. In addition to the adjustment of the flow of refrigerant, valves ensure compensation for the pressure drop in the evaporator.

If the superheat climbs (indicating increasing load), valves allow more refrigerant to be added. If the superheat drops, valves reduce the refrigerant flow rate. In this way, valves make the evaporator more efficient. Electronic valves are especially suitable for plants with varying refrigeration loads.

Many refrigeration plants already have thermostatic expansion valves on their equipment, but these don't work well with widely varying changes in evaporation temperature.

System electronic valves maximize efficiency and save energy in two main ways:

- ▶ This measures pressure and temperature of the refrigerant more precisely, which optimizes cooling capacity and minimizes energy use.
- ▶ This allows the compressor suction temperature to be reduced, and therefore the pressure (decreases the compression ratio and therefore energy use).
- ▶ When the compressor discharge pressure is allowed to vary with the condensation temperature, it provides for efficiency of the refrigeration cycle.

Investment and saving

Costs depends on the size of the plant, but a typical valve would be around 2 000 € plus another 1 000 € for installation. For instance, a 100 kW cooling capacity chiller operating for 8 000 hours a year, is expected to save 2000 € – paying back the investment in 1.5 years. If you are using electronic expansion valves, make sure that:

- ▶ No refrigerant vapour in the liquid line
- ▶ Minimum pressure drop in the liquid (valve; filter...)

5.2.3 TECHNICAL REQUIREMENTS AND RECOMMENDATIONS

This energy saving strategy should be implemented by refrigeration plan maintenance companies.

By evaluating the design and components used in the refrigeration plant it is proposed to prepare a list of components (valves, pipes, ..) responsible for heat loss and pressure drops in the refrigeration system, and plan their gradual substitution based on economic criteria.

Repairing any important weak point in the pipe system thermal insulator from the high stage liquid separator to the low stage one (thermal insulation of pipes of refrigeration systems), or other equipment.

5.2.4 ENERGY SAVING POTENTIAL

The following table shows the possible energy saving that could be achieved at refrigeration plants evaluated during the COOL-SAVE project according to different activities (NACE CODE) and different level of annual energy consumption.

Table 5.1 - Examples of repairing any important weak point in the pipe system (thermal insulation of pipes of refrigeration systems), or other equipment

COMPANY	NACE CODE	Refrigeration plant annual consumption (kWh)	SAVING (EUR/ YEAR)	ESTIMATED ENERGY SAVING kWh	% SAVING
Global		5.803.220	10.492 €	116.064	2,0%
N	NACE 103	1.261.669	2.281 €	25.233	2,0%
Q	NACE 103	4.541.551	8.211 €	90.831	2,0%

Table 5.2 - Examples of switching the valves at the suction line for others with a lower pressure drop (new high technology valves)

COMPANY	NACE CODE	Refrigeration plant annual consumption (kWh)	SAVING (EUR/ YEAR)	ESTIMATED ENERGY SAVING kWh	% SAVING
Global		14.068.286	24.782 €	247.207	1,8%
N	NACE 103	1.261.669	3.328 €	36.810	2,9%
E	NACE 110	2.935.110	2.456 €	-	0,0%
Q	NACE 103	4.541.551	14.202 €	157.098	3,5%
B	NACE 102	5.329.956	4.797 €	53.300	1,0%

Table 5.3 - Examples of resizing the whole pipe system/equipment

COMPANY	NACE CODE	Refrigeration plant annual consumption (kWh)	SAVING (EUR/ YEAR)	ESTIMATED ENERGY SAVING kWh	% SAVING
Global		24.001.433	29.719 €	183.577	0,8%
H	NACE 101	242.000	12.100 €	12.100	5,0%
O	NACE 102	1.050.000	1.890 €	-	0,0%
I	NACE 102	1.384.710	985 €	10.939	0,8%
F	NACE 103	1.586.553	3.370 €	37.443	2,4%
G	NACE 102	1.799.242	291 €	3.239	0,2%
U	NACE 105	2.000.000	3.240 €	60.000	3,0%
E	NACE 110	2.935.110	2.456 €	-	0,0%
B	NACE 102	5.329.956	- €	-	0,0%
X	NACE 101	7.673.863	5.387 €	59.856	0,8%

Table 5.4 - Examples of improvement of maintenance

COMPANY	NACE CODE	Refrigeration plant annual consumption (kWh)	SAVING (EUR/ YEAR)	ESTIMATED ENERGY SAVING kWh	% SAVING
Global		4.689.669	11.017 €	30.216	0,6%
N	NACE 103	1.261.669	2.732 €	30.216	2,4%
V	NACE 104	1.428.000	8.286 €	-	0,0%
U	NACE 105	2.000.000	- €	-	0,0%

5.2.5 IMPLEMENTATION COST AND RETURN ON THE INVESTMENT

The next table shows the cost of the implementation of the strategy and the amount of money saved at refrigeration plants evaluated during the COOL-SAVE project, for different activities (NACE CODE) and different level of annual energy consumption.

The “return on investment” is also calculated for each refrigeration plant so the financial viability of implementing the strategy can be evaluated.

Table 5.5 - Examples of repairing any important weak point in the pipe system (thermal insulation of pipes of refrigeration systems), or other equipment

COMPANY	NACE CODE	Refrigeration plant annual consumption (kWh)	TOTAL STRATEGY COST	SAVING (EUR/YEAR)	ROI
Global		5.803.220	112.000 €	10.492 €	10,7
N	NACE 103	1.261.669	56.000 €	2.281 €	24,5
Q	NACE 103	4.541.551	56.000 €	8.211 €	6,8

Table 5.6 - Examples of switching the valves at the suction line for others with a lower pressure drop (new high technology valves)

COMPANY	NACE CODE	Refrigeration plant annual consumption (kWh)	TOTAL STRATEGY COST	SAVING (EUR/YEAR)	ROI
Global		14.068.286	108.420 €	24.782 €	4,4
N	NACE 103	1.261.669	45.000 €	3.328 €	13,5
E	NACE 110	2.935.110	16.800 €	2.456 €	6,8
Q	NACE 103	4.541.551	45.000 €	14.202 €	3,2
B	NACE 102	5.329.956	1.620 €	4.797 €	0,3

Table 5.7 - Examples of resizing the whole pipe system/equipment

COMPANY	NACE CODE	Refrigeration plant annual consumption (kWh)	TOTAL STRATEGY COST	SAVING (EUR/YEAR)	ROI
Global		24.001.433	53.053 €	29.719 €	1,8
H	NACE 101	242.000	- €	12.100 €	-
O	NACE 102	1.050.000	3.000 €	1.890 €	1,6
I	NACE 102	1.384.710	1.620 €	985 €	1,6
F	NACE 103	1.586.553	2.363 €	3.370 €	0,7
G	NACE 102	1.799.242	1.620 €	291 €	5,6
U	NACE 105	2.000.000	9.000 €	3.240 €	2,8
E	NACE 110	2.935.110	9.800 €	2.456 €	4,0
B	NACE 102	5.329.956	9.450 €	- €	
X	NACE 101	7.673.863	16.200 €	5.387 €	3,0

Table 5.8 - Examples of improvement of maintenance

COMPANY	NACE CODE	Refrigeration plant annual consumption (kWh)	TOTAL STRATEGY COST	SAVING (EUR/YEAR)	ROI
Global		4.689.669	40.500 €	11.017 €	3,7
N	NACE 103	1.261.669	21.000 €	2.732 €	7,7
V	NACE 104	1.428.000	10.500 €	8.286 €	1,3
U	NACE 105	2.000.000	9.000 €	- €	

5.3 CYCLE OPTIMISATION

5.3.1 OBJECTIVE

Readjust the refrigeration thermodynamic cycle parameter values to optimize performance and reduce energy consumption.

5.3.2 TECHNICAL DESCRIPTION

5.3.2.1 Control and optimization of cooling cycle temperatures and pressures

This guide focuses on the so-called “vapour compression cycle”, because of its relevance and predominance in the food and drink industry.

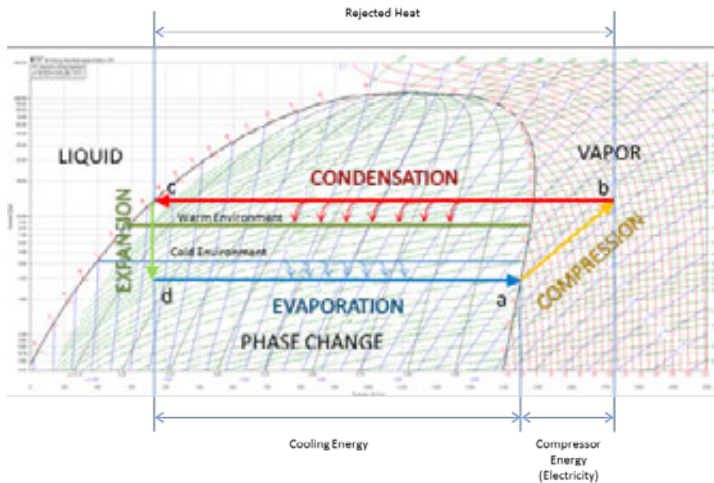

Figure 5.7 - Typical single-stage vapour compression cycle

The vapour compression cycle in its four main phases:

- ▶ **Compression:** Refrigerant enters the compressor as saturated vapour and is compressed to a higher pressure. As a result of this compression, its temperature rises above the temperature of the warm medium;
- ▶ **Condensation:** Refrigerant enters the condenser as a superheated vapour. Its higher temperature makes it possible to cool it using a warm medium, such as ambient air. This high pressure vapour condensates, becoming a high pressure liquid,
- ▶ **Expansion:** The high pressure liquid refrigerant enters a device known as a thermal expansion valve or throttle valve, where it suffers a sudden pressure drop. This pressure drop causes part of the liquid to flash into vapour, reducing the overall temperature of the refrigerant to below the temperature of the cold medium which should be cooled,
- ▶ **Evaporation:** The low pressure refrigerant enters the evaporator where by virtue of its low temperature it is now capable of extracting heat from the cool medium. This energy evaporates the refrigerant, bringing it back to the saturated vapour state where it is ready to enter the compressor again and restart the cycle.

It can be seen that the input energy expenditure (compressor energy) is significantly lower than the useful cooling effect (cooling energy). The ratio between these two magnitudes is referred as COP (Coefficient of Performance). A “high” COP is desired but the absolute value varies greatly depending on operating conditions so comparison of COP can only be done based on a given operating condition. System Efficiency Index (SEI) compares the measured COP with an ideal process at the given conditions. Inside the bell-shaped line of the phase-change zone, each pressure translates to a fixed temperature. In this way, the ratio between condensation and evaporation temperatures translates to a pressure ratio. It is easy to infer that the higher the compression ratio, the higher the compressors’ consumption.

- ▶ Whenever possible, use refrigeration of lower temperature than required is to be avoided, as the production of each degree of decreased temperature increases the energy consumption by an order of magnitude of 3-5%.

There are obvious advantages to having few large supply systems but it can be very costly to reduce the evaporation temperature on a large system to supply a small load with special requirements. The required temperature levels should continuously be re-evaluated.

- ▶ In the same way, an increased condensing pressure/temperature will result in a 1-3% higher energy consumption. It is common that condensing temperatures are kept at a high level through the controls and significant savings can be achieved by optimising these controls (see section on condensers and controls).

5.3.2.2 Practical general guidelines

As a general rule of thumb, evaporating temperatures should be as high as the needs of the process allow, and condensing temperatures should be as low as the environment allows and the equipment withstands. Condensing temperature can be made to vary according to the environment, resulting in savings that are in general proportional to the outdoor temperature swings (if outdoor temperature is a constant variable, condensing temperature has zero benefits). In multi-stage systems, the optimization of intermediate temperatures and pressures results from a compromise between raising the high stage evaporating temperatures and lowering the low stage condensing temperatures.

5.3.2.3 Single stage systems

Figure 5.8 depicts the same basic cooling cycle (a-b-c-d) shown on Figure 5.7, and another cycle (a1-b1-c-d1) which corresponds to the first but with a decrease in evaporation temperature. There is a slight reduction in cooling energy and a simultaneous increase in compressor energy, leading to a lower COP (poorer energetic performance of the cycle). For this reason, the evaporating temperature should always be kept at the maximum possible value. Of course, the maximum evaporating temperature is limited by the need to maintain a temperature difference with respect to the load, and is actively controlled on most systems. Nevertheless it is possible to use higher evaporating temperatures by increasing heat transfer efficiency from the refrigerant to the load (better or cleaner exchangers, for instance); elimination of unwanted energy gains (cooling losses – such as by deficient insulation, pressure drops, etc.). As a general rule, an increase of 1°C in the evaporating temperature results in about 3% energy savings.

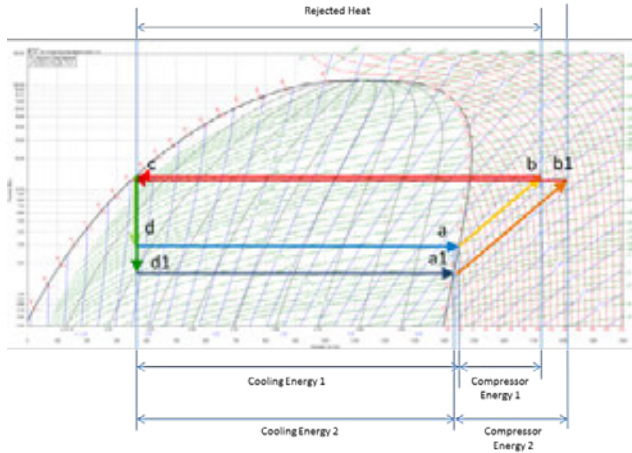

Figure 5.8 - Cold side temperature (evaporation) - Decrease in evaporating temperature

Figure 5.9 depicts the same basic cooling cycle (a-b-c-d) and another cycle (a-b1-c1-d1) which corresponds to the first but with an increase in condensation temperature. It can easily be observed that there is a reduction in cooling energy and simultaneously an increase in compressor energy, leading to a lower COP (poorer energetic performance of the cycle).

For this reason the condensing temperature should always be kept at the minimum possible. Of course, the minimum condensing temperature is limited by the need to maintain a temperature difference with respect to the condensing medium (*warm environment* on Figure 5.9), but it is very common to have systems where the condensing temperature is set at a fixed value regardless of the fluctuations in the condensing medium's temperature. In these cases, it is advisable to install a variable condensing temperature control which allows the system to work with the lowest possible condensing temperature at all times.

As a general rule, a decrease of 1°C in the condensing temperature results in about 1% energy savings.

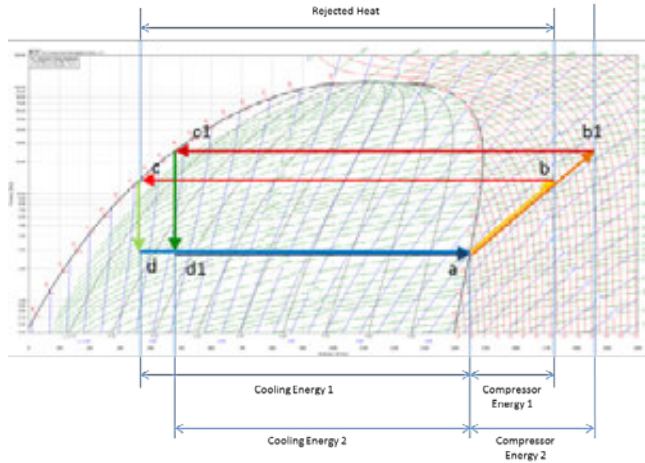

Figure 5.9 - Warm side temperature (condensation) - Increase in condensing temperature

5.3.2.4 Multi-stage systems

In applications demanding very low temperatures, the pressure ratio required is also very high. Compressors have a poor efficiency at very high compression ratios, making single-stage cycles working at very low evaporating temperatures inefficient. To overcome this problem, two-stage systems are often employed, using two compressors each facing a more manageable compression ratio. Below, the Figure 5.10 depicts both alternatives for given evaporation and condensation temperatures.

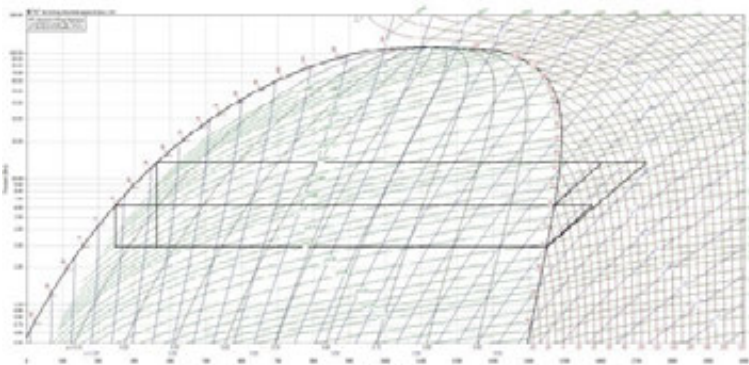

Figure 5.10 - Intermediate temperatures and pressures - Single vs. dual-stage cooling cycle

It can be seen that the total work being performed by the compressors in the multi-stage system is lower than in their single-stage counterpart, while the cooling effect is higher⁴. A rough estimate for the optimum intermediate pressure is given by

$$\text{Equation 1} - P_{int} = \sqrt{P_{asp} \times P_{dis}}$$

5.3.2.5 Implementation

The implementation of the strategies described above is generally not technically challenging, and depending on the specific characteristics of each plant they can have rather significant potential for energy savings. Climates with higher daily seasonal temperature swings are good candidates for optimization of the condensing temperatures; plants with long or complex refrigerant distribution lines are good candidates for optimization of evaporating temperatures (by upgrading thermal isolation, reducing pressure losses and/or optimizing terminal elements); plants with multi-stage cycles should be checked for correctness of intermediate parameters.

Refrigerant charge and expansion devices

- ▶ Refrigerant charge - subcool and superheat should be documented and compared with manufacturer recommendation best practices for each system and component

5.3.3 TECHNICAL REQUIREMENTS AND RECOMMENDATIONS

To optimize the refrigeration system configuration, it is necessary to measure refrigeration and cooling demand. With this data, and the current load curves an expert can adjust the configuration parameters of the refrigeration plant.

It is recommended to have a detailed and permanent monitoring system, so that the data available is as accurate as possible.

Currently, there are some tools to monitor and to measure the COP (Coefficient Of Performance) in real time, so the cooling demand is known permanently. (example: Industrial Refrigeration System / IRS from ITCL).

Once the real loads and performance of the refrigeration plant are determined, the control parameters should be recalculated.

⁴ For unit mass of refrigerant – note that multi-stage cycles have different refrigerant mass flows on the high and low stages.

5.3.4 ENERGY SAVING POTENTIAL

The next table shows the possible energy savings that could be achieved at refrigeration plants evaluated during the COOL-SAVE project for different activities (NACE CODE) and different levels of annual energy consumption.

Table 5.9 - Examples of control and optimization of cooling cycle temperatures and pressures actions

COMPANY	NACE CODE	Refrigeration plant annual consumption (kWh)	SAVING (EUR/ YEAR)	ESTIMATED ENERGY SAVING kWh	% SAVING
Global		46.717.792	600.494 €	6.840.465	14,6%
W	NACE 101	35.258	983 €	10.926	31,0%
R	NACE 105	694.000	11.937 €	138.800	20,0%
O	NACE 102	1.050.000	1.890 €	31.500	3,0%
I	NACE 102	1.384.710	24.763 €	275.142	19,9%
V	NACE 104	1.428.000	6.214 €	-	0,0%
F	NACE 103	1.586.553	19.562 €	217.358	13,7%
G	NACE 102	1.799.242	27.982 €	310.909	17,3%
T	NACE 110	2.086.798	29.148 €	323.871	15,5%
D	NACE 105	2.335.000	7.642 €	65.600	2,8%
S	NACE 107	3.205.862	49.771 €	553.011	17,3%
B	NACE 102	5.329.956	138.392 €	1.537.692	28,9%
X	NACE 101	7.673.863	91.090 €	1.012.106	13,2%
P	NACE 105	8.000.000	43.200 €	720.000	9,0%
M	NACE 101	10.108.550	147.919 €	1.643.549	16,3%

5.3.5 IMPLEMENTATION COST AND RETURN ON THE INVESTMENT

The next table shows the cost of the implementation of the strategy and the amount of money saved at refrigeration plants evaluated during the COOL-SAVE project, for different activities (NACE CODE) and different levels of annual energy consumption.

The “return on investment” is also calculated for each refrigeration plant, so that the financial viability of implementing the strategy can be evaluated.

Table 5.10 - Examples of control and optimization of cooling cycle temperatures and pressures actions.

COMPANY	NACE CODE	Refrigeration plant annual consumption (kWh)	TOTAL STRATEGY COST	SAVING (EUR/YEAR)	ROI
Global		46.717.792	416.700 €	600.494 €	0,7
W	NACE 101	35.258	10.100 €	983 €	10,3
R	NACE 105	694.000	- €	11.937 €	-
O	NACE 102	1.050.000	3.000 €	1.890 €	1,6
I	NACE 102	1.384.710	30.000 €	24.763 €	1,2
V	NACE 104	1.428.000	31.500 €	6.214 €	5,1
F	NACE 103	1.586.553	50.000 €	19.562 €	2,6
G	NACE 102	1.799.242	30.000 €	27.982 €	1,1
T	NACE 110	2.086.798	20.000 €	29.148 €	0,7
D	NACE 105	2.335.000	29.100 €	7.642 €	3,8
S	NACE 107	3.205.862	30.000 €	49.771 €	0,6
B	NACE 102	5.329.956	42.000 €	138.392 €	0,3
X	NACE 101	7.673.863	30.000 €	91.090 €	0,3
P	NACE 105	8.000.000	51.000 €	43.200 €	1,2
M	NACE 101	10.108.550	60.000 €	147.919 €	0,4

5.4 OPTIMISATION OF CONDENSER PERFORMANCE

5.4.1 OBJECTIVE

Improve condenser performance to raise refrigeration capacity and to reduce energy consumption.

5.4.2 TECHNICAL DESCRIPTION

The most cost effective and easiest energy saving measure in plants is often to ensure that condensing pressure is kept at a minimum. Traditionally design has been done for the hottest day and frequently the condensing controls are keeping the condensing pressure near this value by shutting of fans or with control valves when water condensers are used. In most such plants there are often possibilities to save 10-25% of energy by allowing the high pressure to “float” to the lowest

acceptable level for compressor and expansion valves. This can sometimes be done purely by changing set points to the lowest allowed by compressor manufacturer while monitoring system behaviour to see if any problems with controls occur. In some systems this measure should be combined with improved control of fans through variable speed for the fans to avoid undesirable large swings in condensing pressure when fans cycle at low ambient temperatures. Large steps in condensing have an impact on the stability in the overall system.

5.4.2.1 Condenser – cooling tower/dry coolers

Temperature difference between secondary media (air/water/brine) and condensing temperature is the main indicator of the efficiency of the condenser.

5.4.2.2 Heat transfer on warm side

Condenser performance – Temperature difference dT between condensing temperature and temperatures of secondary media should be compared with manufacturer recommendation and good practice.

Increasing condensation pressure typically results in increased energy consumption by 1-3% per degree. For a particular system the compressor software can be used to evaluate the change from one condition to another.

- ▶ Condenser/cooling towers' heat transfer surfaces should be checked for fouling.

5.4.2.3 Flow rates

Air and/or water flow are essential for performance and should be evaluated either as absolute values on flow or with documentation of resulting temperature differences that highlight the performance often in a very direct and cost effective way. Too low flows create a low evaporation and too high flows result in high energy consumption for fans and pumps. In systems intended to work with sub cooling, this could have a negative impact on cycle performance.

- ▶ There will be an optimum flow that varies with capacity, often making variable speed drives on fans/pumps cost effective.
- ▶ In the case of cooling tower or evaporative condensers, adding a regulation on the external temperature is not relevant. A humidity sensor should be added in order to follow the wet bulb temperature.

5.4.2.4 Cooling tower/evaporative condensers

Cooling tower and evaporative condenser performance is based on the “range” (temperature variation of the water) and the “approach” (pinch of the tower, that is to say the difference between the output water temperature and the wet bulb temperature of the external air).

- ▶ Fan power consumption should be documented and evaluated. Systems should be evaluated for sizing and potential fouling of heat exchangers.
- ▶ That air and water is effectively distributed should be verified
- ▶ Recirculation of air should be avoided

5.4.3 TECHNICAL REQUIREMENTS AND RECOMMENDATIONS

The first actions should be focused on achieving the best possible performance value of condensers. It is recommended to review the maintenance of the equipment and the configuration parameters. The climate zone where the refrigeration plant is located has a major influence on the condensers configuration values to use.

Analyzing high pressure values can be detected if it is necessary to increase the number of condensers to use.

5.4.4 ENERGY SAVING POTENTIAL

The next table shows the possible energy saving which could be achieved at refrigeration plants evaluated during the COOL-SAVE project, for different activities (NACE CODE) and different levels of annual energy consumption.

Table 5.11 - Example of replacement of fans at the condenser

COMPANY	NACE CODE	Refrigeration plant annual consumption (kWh)	SAVING (EUR/YEAR)	ESTIMATED ENERGY SAVING kWh	% SAVING
Global		1.261.669	4.115	0,3%	6.000 €
N	NACE 103	1.261.669	4.115	0,3%	6.000 €

Table 5.12 - Example of optimization of intermediate pressure in two stage/cascade systems (CO₂-NH₃,...)

COMPANY	NACE CODE	Refrigeration plant annual consumption (kWh)	SAVING (EUR/YEAR)	ESTIMATED ENERGY SAVING kWh	% SAVING
Global		20.988.276	32.204 €	357.827	1,7%
S	NACE 107	3.205.862	- €	-	0,0%
X	NACE 101	7.673.863	20.650 €	229.449	3,0%
M	NACE 101	10.108.550	11.554 €	128.379	1,3%

Table 5.13 - Examples of improvement of condenser efficiency - Installation of variable speed devices (VSD)

COMPANY	NACE CODE	Refrigeration plant annual consumption (kWh)	SAVING (EUR/YEAR)	ESTIMATED ENERGY SAVING kWh	% SAVING
Global		14.244.291	29.049 €	194.819	1,4%
O	NACE 102	1.050.000	5.355 €	89.250	8,5%
C	NACE 101	1.499.187	14.193 €	-	0,0%
F	NACE 103	1.586.553	6.954 €	77.265	4,9%
M	NACE 101	10.108.550	2.547 €	28.304	0,3%

Table 5.14 - Example of substitution of heat exchanger NH₃/CO₂

COMPANY	NACE CODE	Refrigeration plant annual consumption (kWh)	SAVING (EUR/YEAR)	ESTIMATED ENERGY SAVING kWh	% SAVING
Global		8.000.000	43.200 €	720.000	9,0%
P	NACE 105	8.000.000	43.200 €	720.000	9,0%

5.4.5 IMPLEMENTATION COST AND RETURN ON THE INVESTMENT

The next table shows the cost of implementation of the strategy and the amount of money saved at refrigeration plants evaluated during the COOL-SAVE project, for different activities (NACE CODE) and different levels of annual energy consumption.

The “return on investment” is also calculated for each refrigeration plant so the financial viability of implementing the strategy can be evaluated.

Table 5.15 - Example of replacement of fans at the condenser

COMPANY	NACE CODE	Refrigeration plant annual consumption (kWh)	TOTAL STRATEGY COST	SAVING (EUR/ YEAR)	ROI
Global		1.261.669	6.000 €	372 €	16,1
N	NACE 103	1.261.669	6.000 €	372 €	16,1

Table 5.16 - Example of optimization of intermediate pressure in two stage/ cascade systems (CO₂-NH₃,...)

COMPANY	NACE CODE	Refrigeration plant annual consumption (kWh)	TOTAL STRATEGY COST	SAVING (EUR/ YEAR)	ROI
Global		20.988.276	36.000 €	32.204 €	1,1
S	NACE 107	3.205.862	12.000 €	- €	
X	NACE 101	7.673.863	12.000 €	20.650 €	0,6
M	NACE 101	10.108.550	12.000 €	11.554 €	1,0

Table 5.17 - Examples of improvement of condenser efficiency - Installation of variable speed devices (VSD)

COMPANY	NACE CODE	Refrigeration plant annual consumption (kWh)	TOTAL STRATEGY COST	SAVING (EUR/ YEAR)	ROI
Global		14.244.291	84.450 €	29.049 €	2,9
O	NACE 102	1.050.000	11.250 €	5.355 €	2,1
C	NACE 101	1.499.187	43.500 €	14.193 €	3,1
F	NACE 103	1.586.553	8.100 €	6.954 €	1,2
M	NACE 101	10.108.550	21.600 €	2.547 €	8,5

Table 5.18 - Example of substitution of heat exchanger NH₃/CO₂

COMPANY	NACE CODE	Refrigeration plant annual consumption (kWh)	TOTAL STRATEGY COST	SAVING (EUR/ YEAR)	ROI
Global		8.000.000	161.500 €	43.200 €	3,7
P	NACE 105	8.000.000	161.500 €	43.200 €	3,7

5.5 OPTIMISATION OF EVAPORATOR PERFORMANCE

5.5.1 OBJECTIVE

Increase refrigeration capacity in chambers and tunnels by using more low pressure values and reducing compressors' energy consumption.

5.5.2 TECHNICAL DESCRIPTION

Temperature differences between required temperatures in production and temperatures in storage areas will play a key role in system efficiency and should be evaluated. Industrial plants can work with direct or indirect systems using water, glycol, brine or oils as secondary media to distribute cooling.

Selection of secondary media should be done with consideration to freeze point and corrosion, viscosity and heat transfer properties.

- ▶ The quality of secondary media should be validated as poor quality of secondary fluid can result in high energy consumption and risk for corrosion or foaming. A regular test of fluid quality is normally a good preventive measure.

Systems can use flooded systems with or without pump circulation or direct expansion. Ice storage is also common in industrial plants. A decrease of evaporation temperature typically results in an increase of energy consumption by 3-5%. For a particular system the compressor software can be used to evaluate the change from one condition to another.

5.5.2.1 Heat transfer on cold side

Evaporator performance – dT between evaporation temperature and secondary media temperatures should be compared with manufacturer recommendation and good practice.

5.5.2.2 Evaporator/Evaporators flow rate

An evaporation temperature will be sensitive to the flow of air or used liquids and any fouling in the system. At a given entering temperature, a high flow on secondary media is an advantage but as pressure drop increases with the square off the flow increase, thus increasing pump/fan power drastically.

- ▶ There will be an optimum flow that varies with capacity resulting in that variable speed drive on fans/pumps are often an advantage.
- ▶ With secondary media extra focus should be given to the risk of air, cavitation and foaming in the media as this can decrease heat transfer.

5.5.3 TECHNICAL REQUIREMENTS AND RECOMMENDATIONS

Variable speed devices and a good control of the low pressure separator allows for easier adaption of the cooling and refrigeration process to real demand.

Increasing evaporators' performance allows to increase refrigeration systems' low pressure values, and consequently, to reduce energy consumption of the compressors.

5.5.4 ENERGY SAVING POTENTIAL

The next table shows the possible energy saving which could be achieved at refrigeration plants evaluated during the COOL-SAVE project, for different activities (NACE CODE) and different levels of annual energy consumption.

Table 5.19 - Example of installation of electronic valves after studying the existing expansion (electronic valves)

COMPANY	NACE CODE	Refrigeration plant annual consumption (kWh)	SAVING (EUR/YEAR)	ESTIMATED ENERGY SAVING kWh	% SAVING
Global		24.001.433	29.719 €	183.577	0,8%
H	NACE 101	242.000	12.100 €	12.100	5,0%
O	NACE 102	1.050.000	1.890 €	-	0,0%
I	NACE 102	1.384.710	985 €	10.939	0,8%
F	NACE 103	1.586.553	3.370 €	37.443	2,4%
G	NACE 102	1.799.242	291 €	3.239	0,2%
U	NACE 105	2.000.000	3.240 €	60.000	3,0%
E	NACE 110	2.935.110	2.456 €	-	0,0%
B	NACE 102	5.329.956	- €	-	0,0%
X	NACE 101	7.673.863	5.387 €	59.856	0,8%

Table 5.20 - Example of replacement of fans at the evaporators

COMPANY	NACE CODE	Refrigeration plant annual consumption (kWh)	SAVING (EUR/YEAR)	ESTIMATED ENERGY SAVING kWh	% SAVING
Global		2.311.669	3.944 €	59.520	2,6%
O	NACE 102	1.050.000	2.835 €	47.250	4,5%
N	NACE 103	1.261.669	1.109 €	12.270	1,0%

5.5.5 IMPLEMENTATION COST AND RETURN ON THE INVESTMENT

The next table shows the cost of the implementation of the strategy and the amount of money saved at refrigeration plants evaluated during the COOL-SAVE project, for different activities (NACE CODE) and different levels of annual energy consumption.

The “return on investment” is also calculated for each refrigeration plant so the financial viability of implementing the strategy can be evaluated.

Table 5.21 - Example of installation of electronic valves after studying the existing expansion (electronic valves)

COMPANY	NACE CODE	Refrigeration plant annual consumption (kWh)	TOTAL STRATEGY COST	SAVING (EUR/YEAR)	ROI
Global		24.001.433	53.053 €	29.719 €	1,8
H	NACE 101	242.000	- €	12.100 €	-
O	NACE 102	1.050.000	3.000 €	1.890 €	1,6
I	NACE 102	1.384.710	1.620 €	985 €	1,6
F	NACE 103	1.586.553	2.363 €	3.370 €	0,7
G	NACE 102	1.799.242	1.620 €	291 €	5,6
U	NACE 105	2.000.000	9.000 €	3.240 €	2,8
E	NACE 110	2.935.110	9.800 €	2.456 €	4,0
B	NACE 102	5.329.956	9.450 €	- €	
X	NACE 101	7.673.863	16.200 €	5.387 €	3,0

Table 5.22 - Example of replacement of fans at the evaporators

COMPANY	NACE CODE	Refrigeration plant annual consumption (kWh)	TOTAL STRATEGY COST	SAVING (EUR/ YEAR)	ROI
Global		2.311.669	70.500 €	3.944 €	17,9
O	NACE 102	1.050.000	10.500 €	2.835 €	3,7
N	NACE 103	1.261.669	60.000 €	1.109 €	54,1

5.6 REDUCTION OF AUXILIARY LOADS

5.6.1 OBJECTIVE

Reduce energy consumption due to auxiliary loads.

5.6.2 TECHNICAL DESCRIPTION

5.6.2.1 Reducing auxiliary equipment power consumption

In many refrigeration plants, the auxiliary load will represent 10-30% of the total energy consumed making it important to evaluate possible measures to save energy on auxiliary loads. It is very important to reduce the consumption of the fans and pumps. Fans and pumps are installed in condensers and evaporators in industrial refrigeration plants but also in distribution systems. It is common with primary and secondary pumps e.g. distribution pumps and circulation pumps for the evaporator and condensers.

5.6.2.2 High efficiency fan blades

High efficiency fan blades reduce the electric consumption in the motor shafts, moving the air in a most efficient way. Most of the fans on evaporators and condensers, use axial blades made of plastic or stamped metal, obtaining low cost, but without being energy efficient. The fan blades are usually supplied by manufacturers of fan blades and mounted on the electric motor by the manufacturer of the equipment. These fan systems are mass-produced for a wide range of applications and are not necessarily optimized for specific industrial refrigeration equipment. As an example, evaporator fans can operate with low efficiency when using standard sheet metal designs that are not suitable for the high pressure drops that exist in their working cycle in freeze chambers.

High-efficiency fans on the evaporator and on the condenser need less energy to operate and generate less heat loads, thereby reducing the cooling load. The potential energy savings are estimated to be between 3% and 15% of the electric consumption of that equipment.

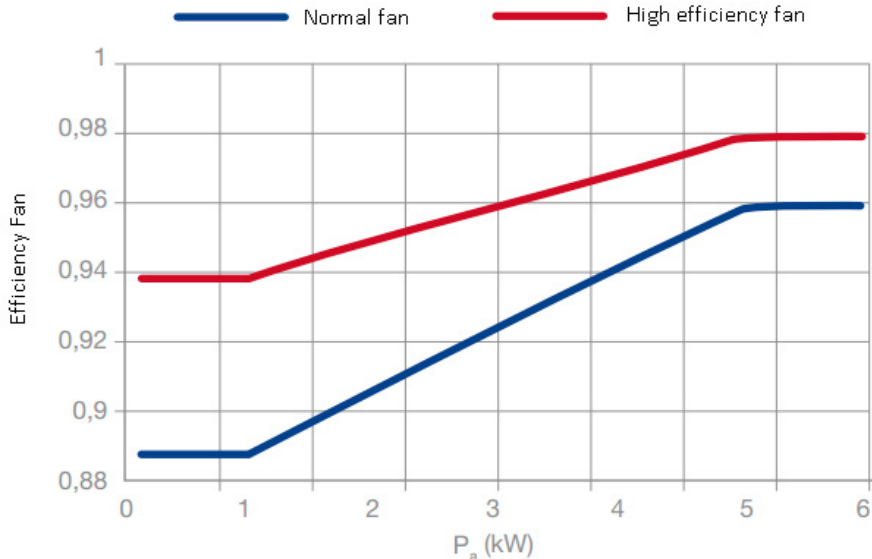

Figure 5.11 - Normal and high efficiency fans

5.6.2.3 High efficiency motors (DC or EC Motors)

There are high-efficiency motors which, when used in conjunction with high-efficiency fans, significantly increase the efficiency of the cycle.

5.6.2.4 Variable speed drives (VSD)

As many pumps and fans are designed for full load and normal operation is with partial load there are significant savings to be made by adjusting flow to actual demand. When evaluating installation of VSD, it is important to consider whether the alternative with a new DC/EC motor fan or pump with variable speed is more cost effective than a VSD drive on existing traditional motors.

- ▶ Installing VSD on distribution systems (fans and pumps) can often save significant amounts of energy as pumps are designed for peak loads but the flows needed during most operating hours are significantly lower. If a pump designed for a certain flow and pressure drop can work at an average of 70% of

design flow the energy saving will be in the order of 67%. As the power consumption increases drastically with the flow, the energy can be significantly reduced, by but rarely

- ▶ Installing a VSD can be considered
 - ▶ In ammonia pumping system
 - ▶ Condenser, dry coolers and cooling tower fans
 - ▶ Evaporator fans

5.6.3 TECHNICAL REQUIREMENTS AND RECOMMENDATIONS

Various saving strategies to improve auxiliary loads can be implemented by the maintenance staff of companies, such as using more efficient electric motors or fans.

Installing variable speed devices, for example in pumps, should be carried out by refrigeration expert companies, as it could be necessary to adapt the control system program to the new equipment and working capacities.

5.6.4 ENERGY SAVING POTENTIAL

The next table shows the possible energy saving which could be achieved at refrigeration plants evaluated during the COOL-SAVE project, for different activities (NACE CODE) and different levels of annual energy consumption.

Table 5.23 - Examples: Variable speed at pumps

COMPANY	NACE CODE	Refrigeration plant annual consumption (kWh)	SAVING (EUR/YEAR)	ESTIMATED ENERGY SAVING kWh	% SAVING
Global		13.112.720	10.371 €	88.941	0,7%
N	NACE 103	1.261.669	406 €	4.487	0,4%
C	NACE 101	1.499.187	1.239 €	-	0,0%
T	NACE 110	2.086.798	5.202 €	57.804	2,8%
E	NACE 110	2.935.110	1.125 €	-	0,0%
B	NACE 102	5.329.956	2.398 €	26.650	0,5%

Table 5.24 - Examples: Optimizing secondary loads

COMPANY	NACE CODE	Refrigeration plant annual consumption (kWh)	SAVING (EUR/YEAR)	ESTIMATED ENERGY SAVING kWh	% SAVING
Global		12.086.798	28.349 €	1.060.851	8,8%
U	NACE 105	2.000.000	540 €	10.000	0,5%
T	NACE 110	2.086.798	977 €	10.851	0,5%
P	NACE 105	8.000.000	26.832 €	1.040.000	13,0%

5.6.5 IMPLEMENTATION COST AND RETURN ON THE INVESTMENT

The next table shows the cost of implementation of the strategy and the amount of money saved at refrigeration plants evaluated during the COOL-SAVE project, for different activities (NACE CODE) and different levels of annual energy consumption.

The “return on investment” is also calculated for each refrigeration plant so the financial viability of implementing the strategy can be evaluated.

Table 5.25 - Examples: Variable speed at pumps

COMPANY	NACE CODE	Refrigeration plant annual consumption (kWh)	TOTAL STRATEGY COST	SAVING (EUR/YEAR)	ROI
Global		13.112.720	48.450 €	10.371 €	4,7
N	NACE 103	1.261.669	4.000 €	406 €	9,9
C	NACE 101	1.499.187	10.500 €	1.239 €	8,5
T	NACE 110	2.086.798	12.150 €	5.202 €	2,3
E	NACE 110	2.935.110	9.800 €	1.125 €	8,7
B	NACE 102	5.329.956	12.000 €	2.398 €	5,0

Table 5.26 - Examples: Optimizing secondary loads

COMPANY	NACE CODE	Refrigeration plant annual consumption (kWh)	TOTAL STRATEGY COST	SAVING (EUR/YEAR)	ROI
Global		12.086.798	45.806 €	28.349 €	1,6
U	NACE 105	2.000.000	4.500 €	540 €	8,3
T	NACE 110	2.086.798	506 €	977 €	0,5
P	NACE 105	8.000.000	40.800 €	26.832 €	1,5

5.7 OPTIMIZATION OF COMPRESSOR PERFORMANCE

5.7.1 OBJECTIVE

Maintain compressors working at best performance values to increase cooling capacity and reduce energy consumption, ensuring optimum use of installed compressors, and to improve compressor efficiency when working at part loads.

5.7.2 TECHNICAL DESCRIPTION

Compressor isentropic efficiency allows for estimating total losses in compressor and motor operation, and varies greatly according to the type of compressor and working load conditions. Compressor efficiency, in particular at different load conditions, should be documented and evaluated.

As a general rule, reciprocating compressors can be mechanically off-loaded by disconnecting cylinders; with a proper design, performance losses can be limited.

In the case of screw compressors, traditional regulation allows a wider modulation of capacity but also a more significant performance penalty on low capacities. Partial load will typically be the most common operation and the staging of capacity is a key factor for plant efficiency. The type and number of compressors and how they are controlled will define the performance of the global facilities.

In particular, the interaction between control logics and the compressors' efficiency often results in far-from-optimal operation of system.

- ▶ Full and partial load testing is required to evaluate if a compressor is running at its intended efficiency
- ▶ Measurements over time and load variation are required to evaluate actual operating performance and optimize operation of compressors
- ▶ Short cycling with many starts and stops result in increased wear, risk of oil depositing in system and poor lubrication

5.7.2.1 Compressor efficiency (compression ratio vs. operating conditions)

Changing the regime of operation of the electric motor of the compressor mechanically considerably reduces performance. If the compressor operating regime is modified by VSD, the reduction of the efficiency of the equipment is lower. The energy savings that can be obtained by installing variable speed devices depends on the variation of the load of compressors or pumps.

The more the loads vary, the bigger the savings are that can be achieved. Electrical motors working at close to 100% capacity have no chance to reduce energy consumption using VSDs.

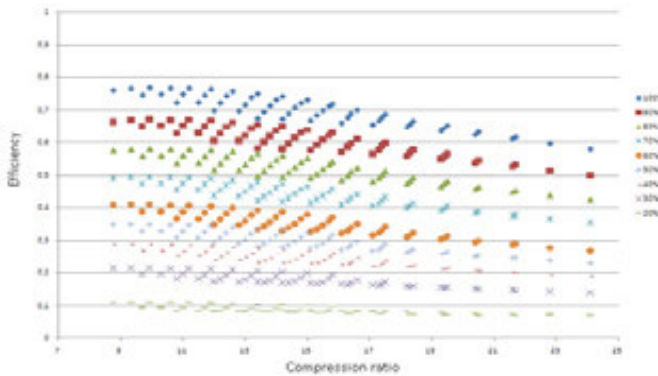

Figure 5.12 - Normal control

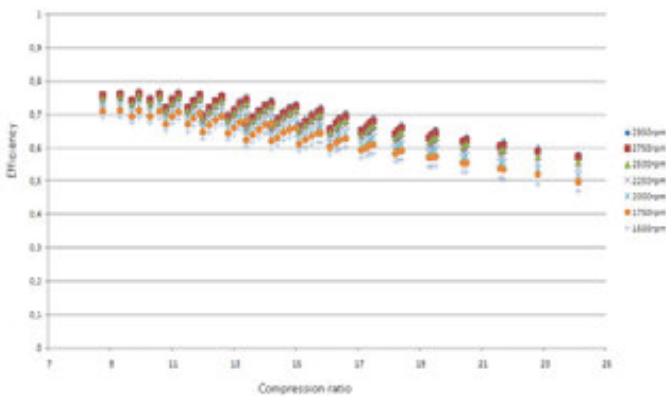

Figure 5.13 - Control with VSD

5.7.2.2 Variable Frequency Drives

Variable frequency drives, or Variable speed drives (VSD) are used to control the rotational speed of an AC electric motor. A VSD keeps control of the input frequency which is supplied to the motor.

In this way, the rotation speed of the electric motor and the compressor vary according to the needs of the facilities, adjusted by an internal or external controller using a set point for pressure or temperature.

Normally, the current compressors have certain possibilities of capacity regulation. Compressors allow a continuous variation of mechanical capacity (i.e. 10% - 100%), which is good for adjusting cooling production to demand, but penalizes greatly the equipment performance.

The ideal solution is to use a variable speed electric motor, which reduces the number of revolutions of the compressor and thus reduces the displacement volume and the cooling capacity of the compressor.

By installing a VSD, compressor efficiency is increased at partial load since when the working load capacity is modified; the penalizations in compressor performance are reduced. In this way, the compressor can vary the load capacity without reducing performance.

Thanks to VSD devices, it is possible to reduce the electric consumption of the equipment, but it requires an economic investment, and also, during the modification, the equipment must remain off.

In this case, the electric consumption of the motor is almost linear to the reduction in capacity. These limitations are in compressor design, lubrication management and refrigeration of moving parts (30Hz - 50Hz).

- ▶ VSD on reciprocating compressors: it consists of a combination of modifying the number of active cylinders in the compressor and the change in rotational speed of the motor
- ▶ VSD on screw compressor: there is a better adjustment than in reciprocating compressors. Here, the mechanical capacity control system (0-100%) is combined with the setting of the rotational speed of the electric motor

Installing a VSD, the compressor efficiency is increased since when the working load capacity is modified, the penalizations in compressor performance are reduced. In this way, the compressor can vary the load capacity without reducing the performance.

5.7.2.3 Optimize compressors capacity

At the design of a refrigeration plant, often large compressors adapted to peak loads are installed, but refrigeration systems often never (or at least rarely) work at these peak loads.

In spite of that, as design often focuses on full load capacity and performance, and this might never occur in the normal use of the plant, it is unusual to achieve peak load COP, which has an impact on annual operating cost.

Typically, operating load conditions between 30% and 80% are much more common than full load operation conditions. Different compressor designs have different partial load characteristics and Variable Speed Drives (VSD) have become more and more competitive as investments have decreased at the same time as energy prices have increased.

Screw compressors are typically more sensitive to off-load design capacity than reciprocating compressors. But due to the number of different designs of off-loading, improvement evaluation has to be based on the installed compressor models. Efficiency of compressors is reduced when they run at partial load capacity, particularly with screw compressors, which use a slide valve to control capacity. Figure 5.13. shows a typical relationship between the capacity and the power consumption of a screw compressor operating under partial load.

Reciprocating compressors off loading

A very common method is to adjust the cooling capacity of reciprocating compressors by switching off one or more cylinders. To remove the action of a piston, the suction valve is just kept permanently open. Avoiding peak starting current allows starting the vacuum compressor, however, the variation of the power is not continuous.

As a drawback, the wear on the machine is virtually identical loaded or off-loaded. Such a system is moderately effective in terms of energy. For example, for a cooling power of 50%, the machine still absorbs about 65% of the power of coaching.

Alternatively off-loading off cylinders can be done by closing the suction valve continuously with less decrease of efficiency.

The compressors of a refrigerating system are usually controlled by a system which, in most cases, **maintains and controls capacity with no consideration to energy efficiency**. To adapt the compressors' refrigerating capacity to the

cooling load of the plant, the control system adjusts the part-load compressor capacity and the start-stop sequence of compressors. The compressor part-load control loads or unloads compressors when the plant load increases or decreases. The compressor staging control turns ON the compressors progressively when the demanding cooling load is increasing and turns OFF the compressors progressively when the cooling load is decreasing.

Screw compressor off-loading

In figure 5.14, we can see how the power consumption has only decreased to 70% when the compressor has reduced its capacity down to 60%. This situation gets worse as the compressor reduces capacity. In general, it is very important to keep screw compressors running at the highest load capacity possible. This could be done by means of a variable speed drive (VSD) which allows the compressor to run with the slide valve at 100% capacity while slowing down the motor from 3.600 rpm to 1.800 rpm, thus reducing capacity with higher efficiency (VSD's have a small consumption that must be taken into account when comparing with a slide valve control system). On the other hand, a refrigerating system should have several compressors, so that the different cooling demands that normally occur in a plant can be met by a compressor running close to full load. These compressors should also be of different sizes to meet all load levels at a good level of efficiency. The control system should limit partial load operation by means of a well-defined sequencing of compressor, so that situations with two or more compressors running at partial loads in the same circuit are avoided. This is a solution suitable for most of the refrigerating systems, especially for those with screw compressors and particularly plants where the cooling demand is very variable.

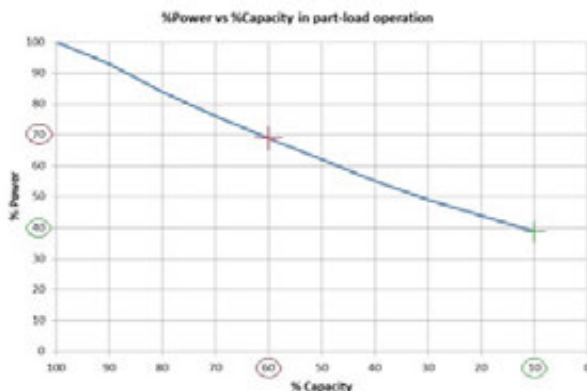

Figure 5.14 - Capacity and power consumption of a screw compressor

Implementing an optimized staging and capacity control could achieve important energy savings and benefits for the refrigerant system:

- ▶ Prevents partial load operations, a major cause of inefficiency in a conventional refrigeration plant
- ▶ Prevents compressors working in short cycles, reduction of compressor starts
- ▶ Rotates compressors on a regular basis to equalize running hours
- ▶ Reduces compressors running hours, which means lower maintenance costs

Before implementation of this solution, a careful performance audit of the refrigeration system should be carried out to determine, among others, how the compressors are working and how they match the cooling demand of the plant. The implementation of this solution is not technically challenging but it must be designed and executed by a specialized company, as it requires deep knowledge about refrigeration and automation. This specialized company should work very closely with the maintenance and production personnel of the customer in order to learn about the work processes of the plant so they can design the control system that best fits to these work processes.

5.7.3 TECHNICAL REQUIREMENTS AND RECOMMENDATIONS

Compressor optimization requires a refrigeration expert company. Some actions necessitate changing the control program, and it is critical to understand the logic used to control the compressors' working sequences.

To install VSD equipment is recommended for plants with freezing and cooling chambers where compressors work much of the time at partial load.

It is also recommended at refrigeration plants where refrigeration capacity is bigger than needed.

To install VSD equipment sometimes providers recommend changing electric motors due to possible problems with motor refrigeration.

5.7.4 ENERGY SAVING POTENTIAL

The following table shows the possible energy savings which could be achieved at refrigeration plants evaluated during the COOL-SAVE project, for different activities (NACE CODE) and different levels of annual energy consumption.

Table 5.27 - Example: Installation of high efficiency engines in compressor

COMPANY	NACE CODE	Refrigeration plant annual consumption (kWh)	SAVING (EUR/YEAR)	ESTIMATED ENERGY SAVING kWh	% SAVING
Global		12.662.017	87.044 €	592.422	4,7%
H	NACE 101	242.000	12.100 €	12.100	5,0%
A	NACE 101	1.132.500	7.928 €	-	0,0%
N	NACE 103	1.261.669	11.405 €	126.167	10,0%
C	NACE 101	1.499.187	4.731 €	-	0,0%
E	NACE 110	2.935.110	9.825 €	-	0,0%

Table 5.28 - Example: Improvement of compressors' efficiency - Optimize compressors working sequence

COMPANY	NACE CODE	Refrigeration plant annual consumption (kWh)	SAVING (EUR/YEAR)	ESTIMATED ENERGY SAVING kWh	% SAVING
Global		16.677.170	199.297 €	2.214.406	13,3%
F	NACE 103	1.586.553	1.642 €	18.245	1,2%
T	NACE 110	2.086.798	49.470 €	549.662	26,3%
B	NACE 102	5.329.956	84.714 €	941.270	17,7%
X	NACE 101	7.673.863	63.471 €	705.228	9,2%

Table 5.29 - Examples of VSD installation at compressors

COMPANY	NACE CODE	Refrigeration plant annual consumption (kWh)	SAVING (EUR/YEAR)	ESTIMATED ENERGY SAVING kWh	% SAVING
Global		45.630.288	313.459 €	4.388.571	9,6%
I	NACE 102	1.384.710	5.693 €	63.281	4,6%
F	NACE 103	1.586.553	2.456 €	27.289	1,7%
G	NACE 102	1.799.242	7.661 €	85.125	4,7%
M	NACE 101	10.108.550	73.418 €	815.760	8,1%
U	NACE 105	2.000.000	21.600 €	400.000	20,0%
S	NACE 107	3.205.862	4.270 €	47.447	1,5%
Q	NACE 103	4.541.551	20.528 €	227.078	5,0%
B	NACE 102	5.329.956	5.586 €	62.064	1,2%

COMPANY	NACE CODE	Refrigeration plant annual consumption (kWh)	SAVING (EUR/YEAR)	ESTIMATED ENERGY SAVING kWh	% SAVING
X	NACE 101	7.673.863	37.847 €	420.528	5,5%
P	NACE 105	8.000.000	134.400 €	2.240.000	28,0%

5.7.5 IMPLEMENTATION COST AND RETURN ON THE INVESTMENT

The next table shows the cost of the implementation of the strategy and the amount of money saved at refrigeration plants evaluated during the COOL-SAVE project for different activities (NACE CODE) and different levels of annual energy consumption.

The “return on investment” is also calculated for each refrigeration plant so the financial viability of implementing the strategy can be evaluated.

Table 5.30 - Example: Installation of high efficiency engines in compressor

COMPANY	NACE CODE	Refrigeration plant annual consumption (kWh)	TOTAL STRATEGY COST	SAVING (EUR/YEAR)	ROI
Global		12.662.017	805.600 €	87.044 €	9,3
H	NACE 101	242.000	- €	12.100 €	-
A	NACE 101	1.132.500	33.600 €	7.928 €	4,2
N	NACE 103	1.261.669	280.000 €	11.405 €	24,5
C	NACE 101	1.499.187	57.000 €	4.731 €	12,0
E	NACE 110	2.935.110	35.000 €	9.825 €	3,6

Table 5.31 - Example: Improvement of compressors’ efficiency - Optimize compressors working sequence

COMPANY	NACE CODE	Refrigeration plant annual consumption (kWh)	TOTAL STRATEGY COST	SAVING (EUR/YEAR)	ROI
Global		16.677.170	99.000 €	199.297 €	0,5
F	NACE 103	1.586.553	18.000 €	1.642 €	11,0
T	NACE 110	2.086.798	36.000 €	49.470 €	0,7
B	NACE 102	5.329.956	22.500 €	84.714 €	0,3
X	NACE 101	7.673.863	22.500 €	63.471 €	0,4

Table 5.32 - Examples of VSD installation at compressors

COMPANY	NACE CODE	Refrigeration plant annual consumption (kWh)	TOTAL STRATEGY COST	SAVING (EUR/YEAR)	ROI
Global		45.630.288	669.050 €	313.459 €	2,1
I	NACE 102	1.384.710	40.500 €	5.693 €	7,1
F	NACE 103	1.586.553	20.250 €	2.456 €	8,2
G	NACE 102	1.799.242	44.550 €	7.661 €	5,8
M	NACE 101	10.108.550	72.900 €	73.418 €	1,0
U	NACE 105	2.000.000	109.200 €	21.600 €	5,1
S	NACE 107	3.205.862	25.650 €	4.270 €	6,0
Q	NACE 103	4.541.551	56.000 €	20.528 €	2,7
B	NACE 102	5.329.956	30.375 €	5.586 €	5,4
X	NACE 101	7.673.863	91.125 €	37.847 €	2,4
P	NACE 105	8.000.000	178.500 €	134.400 €	1,3

5.8 HEAT RECOVERY AND FREE COOLING

5.8.1 OBJECTIVE

Recover refrigeration plant heating potential capacity that is discharged into the atmosphere.

5.8.2 TECHNICAL DESCRIPTION

Cooling cycles operate by displacing heat from a lower temperature medium to a higher temperature medium. The heat released to the high temperature medium is referred to as “rejected heat” and in order to dispose of it most cooling systems employ energy consuming systems such as fans or pumps. On the other hand, most factories which use cooling cycles in their processes also use heat in some other points, either process related or not (domestic hot water, hot water for washing, heat for space air conditioning, etc.). It is therefore possible to use the cooling cycles’ rejected heat to obtain some useful effect, thus avoiding additional energy expenditures. Heat recovery potential can only be fully determined on a installation-by-installation basis, but we shall nonetheless try to give some general indications about its potential applications. It is obvious

that heat recovery should not create an unreliable operation and any investment and increase of operating cost should be evaluated versus saving. To evaluate heat recovery an understanding of the potentially available energy at different temperature levels and how this matches the need for heat in plant is required. Heat recovery can be done in different ways:

- ▶ Heat recovery from current temperature level of condensing
- ▶ Heat recovery in desuperheaters without requiring change in condensing temperature
- ▶ Heat recovery from the level of an increased condensing temperature
- ▶ Heat recovery with application of a heat pump cooling the condensing circuit of the refrigeration plant and increasing the level to a higher level than the condensing (that often can be decreased in such systems)

5.8.2.1 Condenser heat recovery

The condenser is the most obvious starting point in the search for energy recovery potential. Indeed, the condenser has to reject not only the heat removed from the refrigerated medium, but also the majority of the electrical power from the compressor. The downside of the condenser heat recovery approach is that in order to maximize the cooling cycle's efficiency one is forced to minimize the recovered heat's temperature, and thus its "quality" and its potential for use in other processes. This approach can nevertheless serve either as a source of low temperature heat if it is required, or as a pre-heating step. This can be done in different ways - an air condenser can be directly placed in an area that has a heating demand or in a ventilation system that can direct the heat to desired area. When there is a secondary media, e.g. water, it is easy to direct the energy to where the heating is desired. It is also possible to have dual condensers to allow one to reject heat to the ambient air and one to be used for heat recovery.

5.8.2.2 Desuperheaters

The refrigerant leaving the compressor is in super-heated state, meaning that in order for it to start condensing without changing its pressure, it must first be cooled. The amount of heat that has to be extracted from the refrigerant before it begins condensing is called superheat. Desuperheaters are heat exchangers placed before the condenser to ensure that refrigerant enters the condenser as a saturated gas. Heat removed from the refrigerant discharge gas above con-

densing temperature by means of desuperheaters can be used for process heat, pre-heating, or DHW (domestic hot water) production. The temperature level and amount of energy available at higher temperature than condensing vary with the operating conditions and refrigerant. But often 10-30% can be reused without change of condensing temperature.

5.8.2.3 Compressor cooling heat recovery

Some compressors demand dedicated cooling, in order to remain within their working specifications. Heat from compressor crankcase cooling can also be recovered if there is a suitable temperature application available.

5.8.2.4 Oil cooling heat recovery

Some cooling cycles also need dedicated oil cooling, so as to ensure that the oil suffers no thermal degradation and loss of lubricating properties. This heat is also eligible for recovery to use in other processes.

5.8.2.5 Heat pumps

Often, the temperature level of the heat recovered from the cooling cycle is insufficient for the application it is destined to. In these cases a heat pump might provide a high energy efficiency means for doing so. The applicability of a heat pump depends on the required temperature level, since heat pumps, like cooling cycles, also lose efficiency when they face high compression ratios.

5.8.2.6 Thermally driven cooling cycles

Heat recovered from cooling cycles could also be used to produce cooling, rather than heating, effect. Absorption and adsorption coolers are thermally driven cooling cycles, which mean that they use an external source of heat as the main input to produce cooling effect. Vapour ejectors are a very old technology very scarcely used nowadays, but some research is being carried out on integrating them in otherwise conventional cooling cycles to boost their performance⁵. Significant energy savings can be achieved in many industrial plants in the food and drink industry by implementing heat recovery strategies. There is a conservative view in the refrigeration industry resulting in that many opportunities for heat recovery are neglected as they are considered to negatively affect the refrigeration system.

⁵ See for example <http://docs.lib.purdue.edu/iracc/1191/> or <http://www.sciencedirect.com/science/article/pii/S0140700711002192>

5.8.2.7 Free cooling

Ambient air as free cooling

In many processes that do not require low temperatures, there will be a significant number of hours where the ambient temperatures are below those required for cooling. If there are many hours with significant loads during these conditions, it is possible to use the ambient temperatures directly to cool without a refrigeration process. The operating cost of such systems is very low. Sometimes this free cooling can be achieved with existing dry coolers in the plant. Climate data and cooling requirements should be evaluated to define if such systems are cost effective.

Ground storage systems

There are also an increasing number of systems using ground storage to balance loads and combining heating and cooling loads to maximize performance. Such systems can allow chillers and heat pumps to use a storage in the ground through drilled holes. Depending on load patterns and needs this can allow energy to be used more efficiently than without such a buffer. These solutions are receiving increased attention in commercial buildings in cold climates where there is a significant heating demand in the winter and cooling demand in the winter. The heat from the chillers' condensers can then be stored during the summer and used as a heat source for the "heat pump" in the winter (it can be the same machine). A big advantage is that during the spring and early summer ground storage can often be used as free cooling as the temperatures are suitable without a chiller.

Improved control strategies

The most cost effective measure in many plants lies in the optimization of the controls to adapt them to a particular plant and its operation. Typically control systems are set to keep a certain temperature or pressure from a design specification. When this was done there was no knowledge on many of the parameters affecting the control system. This practice and lack of proper commissioning result in that most plants show a significant saving potential - often 10-20%, but sometimes even more - if system controls are modified to achieve best energy performances, taking the local requirements, equipment and response times into account. Each plant will require careful evaluation at different operating conditions to allow best use of installed equipment. It is also important to recognize that an energy-efficient plant normally is the most reliable as well.

Targets are to:

- ▶ Decreasing pressure ratios as much as possible while still achieving the required cooling, i.e. operating at the highest possible setpoint for the evaporator side and the lowest possible setpoint for condenser side
 - ▶ Variable or Floating setpoints for the cold side should be used when suitable. There might be a time where a lower set-point is required, but others where a more economic set point is possible. Modern control systems can often adapt automatically to changing demands, e.g. by monitoring valves in the plant to identify if a higher evaporation can be used
 - ▶ In many plants, variable or floating condensing can result in significant savings in particular in colder climate zones where old habits tend to control the condensing pressure at an unnecessary high level. When adjusting condensing control it is important to create stable operation to avoid unstable operation of the whole system. Variable speed fans can facilitate this when not achieved with on/off of multiple fans
- ▶ Limiting starts and stops creates efficiency and reduces wear
- ▶ Creating stable operating conditions increases reliability and efficiency
- ▶ Harmonizing primary and secondary flows is important to reduce pumping energy in the optimal way and to avoid mixed temperatures that require a lower set-point than that which reaches the “user”

The controls are dealing with a complex system and often the response times are long when a change is made, whereas control systems can react very fast. This results in the fact that in many plants where changes are continuously introduced, the system is “overreacting”, causing e.g. compressors to start and stop. Figure 5.15 below shows the power of two compressors in a chiller before and after adjustment of control.

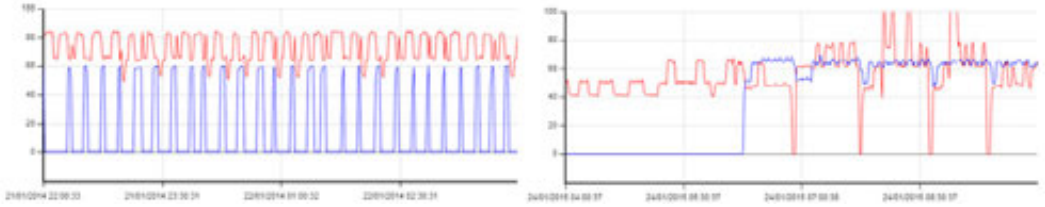

Figure 5.15 - Power of two compressors in a chiller before and after adjustment of control

In many plants, it can be noted how e.g. on/off control of condenser fans trigger compressor controls to step in and out. The reason for this is often that when the fan starts the condenser pressure decreases causing flash gas in the liquid line/receiver which results in less feed of liquid to the low pressure side. This reduces the evaporation, which the control experiences as capacity being too high, resulting in stepping down compressors. This results in that load in condensers decreases and the fan stops. Next, the condenser pressure starts increasing, feeding more liquid, increasing evaporation, compressor capacity increases as well, so that the fan starts, and the cycle starts over. Avoiding these types of cyclic controls requires a good understanding of the operation and a step-by-step approach to find the optimal setting for a specific plant, taking all factors into account and understanding the time constants of the system.

5.8.3 TECHNICAL REQUIREMENTS AND RECOMMENDATIONS

To implement a heat recovery system, or to use a free cooling strategy, it is recommended to conduct a financial and economic feasibility study, and to evaluate the return on investment period.

This kind of strategy requires substantial investment in order to be implemented, which is why it is important to evaluate saving potentials accurately.

5.8.4 ENERGY SAVING POTENTIAL

The next table shows the possible energy savings which could be achieved at refrigeration plants evaluated during the COOL-SAVE project for different activities (NACE CODE) and different levels of annual energy consumption.

Table 5.33 - Possible energy saving

COMPANY	NACE CODE	Refrigeration plant annual consumption (kWh)	SAVING (EUR/ YEAR)	ESTIMATED ENERGY SAVING kWh	% SAVING
Global		42.460.092	848.194 €	7.843.973	18,5%
A	NACE 101	1.132.500	56.625 €	56.625	5,0%
N	NACE 103	1.261.669	8.791 €	97.243	7,7%
F	NACE 103	1.586.553	5.369 €	59.654	3,8%
D	NACE 105	2.335.000	296.959 €	2.549.000	109,2%*
S	NACE 107	3.205.862	10.445 €	116.052	3,6%
B	NACE 102	5.329.956	2.590 €	28.782	0,5%
L	NACE 110	8.700.000	219.600 €	1.830.000	21,0%
K	NACE 110	8.800.000	225.891 €	2.863.000	32,5%
M	NACE 101	10.108.550	21.925 €	243.616	2,4%

*Installation of a heat pump. Savings include decrease of use of combustible consumption to heat water.

5.8.5 IMPLEMENTATION COST AND RETURN ON THE INVESTMENT

The next table shows the cost of the implementation of the strategy and the amount of money saved at refrigeration plants evaluated during the COOL-SAVE project, for different activities (NACE CODE) and different levels of annual energy consumption.

The “return on investment” is also calculated for each refrigeration plant so the financial viability of implementing the strategy can be evaluated.

Table 5.34 - Cost of the strategy implementation, amount of money save and “return on investment”

COMPANY	NACE CODE	Refrigeration plant annual consumption (kWh)	TOTAL STRATEGY COST	SAVING (EUR/ YEAR)	ROI
Global		42.460.092	1.654.600 €	848.194 €	2,0
A	NACE 101	1.132.500	56.000 €	56.625 €	1,0
N	NACE 103	1.261.669	320.000 €	8.791 €	36,4
F	NACE 103	1.586.553	51.300 €	5.369 €	9,6
D	NACE 105	2.335.000	275.000 €	296.959 €	0,9

COMPANY	NACE CODE	Refrigeration plant annual consumption (kWh)	TOTAL STRATEGY COST	SAVING (EUR/ YEAR)	ROI
S	NACE 107	3.205.862	51.300 €	10.445 €	4,9
B	NACE 102	5.329.956	54.000 €	2.590 €	20,8
L	NACE 110	8.700.000	385.000 €	219.600 €	1,8
K	NACE 110	8.800.000	408.000 €	225.891 €	1,8
M	NACE 101	10.108.550	54.000 €	21.925 €	2,5

5.9 IMPROVED CONTROL STRATEGIES

5.9.1 OBJECTIVE

Increase refrigeration plant energy efficiency performance by using more elaborated and personalized control strategies.

5.9.2 TECHNICAL DESCRIPTION

5.9.2.1 Optimized system control

The optimization of the logic control across the full range of the plant operating conditions is essential to achieve the greatest level of energy savings from each technology. As a rule, such optimization requires that the performance of the logic control should be continuously monitored and the various control parameters fine tuned over an extended period so as to capture variations in production and seasonal conditions.

Where the logic is implemented on the plant's computer, "static optimization" (optimization under one set of conditions at the time of implementation) is commonly applied.

In the sector of industrial refrigeration, a product exists that dynamically optimizes the configuration parameters of all equipment in an industrial refrigeration plant, so you can get the maximum performance at each time moment. This product is the IRS & IRC of ITCL "Instituto Tecnológico de Castilla y León".

With the IRS product, you can monitor the performance of all equipment in the refrigeration plant and the global performance of the whole plant at each time moment.



Figure 5.16 - IRS, industrial refrigeration supervision

Also, you can see the cooling production, electric consumption, flow rate or SEI of all compressors.

The IRC software configures all parameters of all equipment in the refrigeration plant, so it is possible to obtain the maximum performance at each time moment.

The IRC software is customized for each refrigerant plant, so it is possible to obtain the maximum performance in the refrigeration cycle.



Figure 5.17 - IRC, industrial refrigeration control

You can obtain the optimal performance at each time moment with the same cooling capacity in your refrigeration plant because this software calculates the optimal control parameters continuously.

5.9.2.2 HP Control

HP control consists in reducing the condensing pressure according to the external temperature in winter and mid-season. It leads to a decrease of the compressor's consumption. Indeed, when the high pressure goes down, the Energy Efficiency Ratio of the compressor increases. The cooling system will produce more cooling energy while consuming less electrical energy.

The establishment of a HP control requires:

- ▶ The installation of outdoor temperature sensors to optimize the condensing pressure according to the weather conditions
- ▶ The installation of one or more variable speed fans to adjust the ventilation power to the outside temperature
- ▶ The installation of an electronic expansion valve

Important: In case of screw compressors, an additional speed control should be installed on the compressor.

5.9.2.3 Evaporative temperature

One of the first steps in sizing a cooling system is to check the cooling need and the quality of the heat exchange. To calculate the heat exchange, the flow velocity has to be measured. This measurement is also a way to detect the presence of bubbles in the liquid phase. For instance, the presence of bubbles after condensation means that the heat exchange is not well designed; in that case the condensation temperature has to be decreased.

In our example, decreasing the condensation temperature of the second compression stage leads to a decrease of the evaporative temperature of the first compression stage. At first glance, decreasing the evaporative temperature is supposed to increase the electrical consumption of a compressor. However, in a cascading installation, a comprehensive analysis shows a decrease of the global consumption. Indeed, the first compression stage degradation is compensated by the decrease of the second compression stage energy efficiency ratio. As we can see in Figure 5.18 below, by reducing the condensing temperature regulation of the first stage (NH₃) **from -14°C to -18°C, the global energy efficiency ratio from measurement decreases from 2.1 to 2.4. Energy saving realized after modification: 9% per year.**

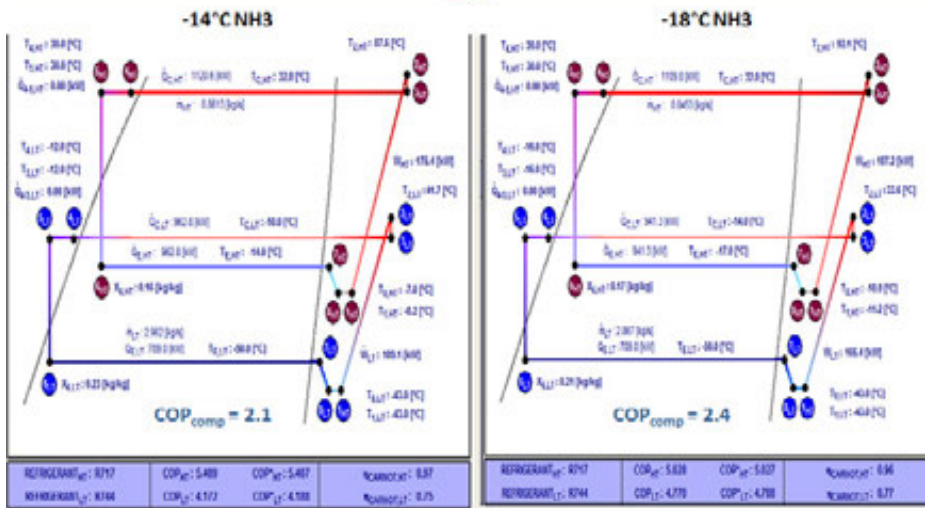

Figure 5.18 - Global energy ratio for -14°C to -18°C

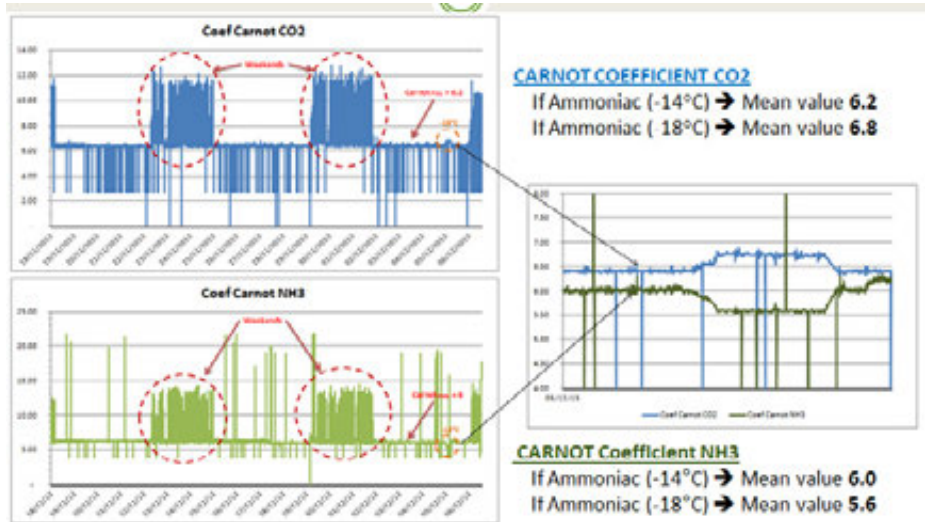

Figure 5.19 - Carnot Coefficient CO₂/Carnot Coefficient NH₃

5.9.2.4 Measures in connection with significant upgrades or expansion of a plant

Installing a CO₂-NH₃ system

CO₂ has been known as a refrigerant for over a century. In fact, it was used extensively from 1920 to 1940, before CFCs were introduced. It was used mainly in marine applications whilst NH₃ was more common in the land applications. With the arrival of new refrigerants, the CO₂ applications decreased. NH₃ has continued to be the dominant refrigerant for industrial refrigeration applications over the years.

Nowadays, the use of CFCs is forbidden due to their high ODP (Ozone Depletion Potential). HFCs have an ODP=0 but unfortunately a high GWP (Global Warming Potential) and are therefore targeted to be reduced in a near future, so there is a renewed focus on the CO₂ applications, as we can see in the industrial refrigeration with the CO₂ - NH₃ combined systems. CO₂ and NH₃ belong to the group called Natural Refrigerants as their ODP and GWP are of no effect. CO₂ has ODP=0 and GWP=1, it is non-flammable and non-toxic, low price, available worldwide and a future-proof solution. On the other side, NH₃ has ODP=0 and GWP=0, toxic but high warning effect, low price, available worldwide and also a future-proof solution. CO₂ - NH₃ systems could be presented in two ways:

CO₂-NH₃ cascade system

In this system, the CO₂ is pumped to the evaporators where it is partially evaporated, the evaporated CO₂ is compressed and condensed in a heat exchanger which acts as the evaporator for the NH₃ side.

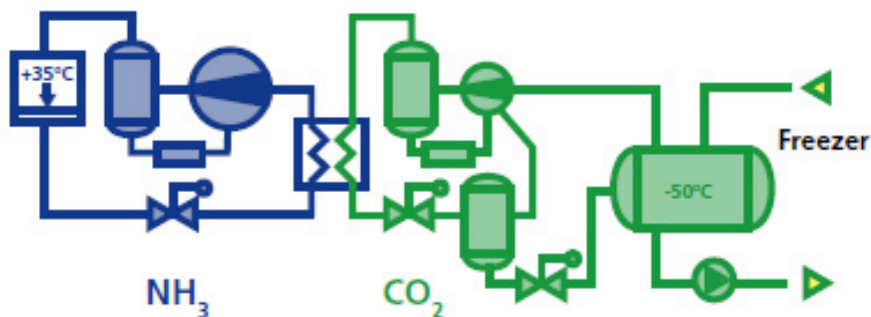

Figure 5.20 - CO₂ - NH₃ cascade system

Due to its high volumetric refrigerant capacity, CO₂ compressors are of small size with a small consumption giving great refrigerant capacities. The overall efficiency of a CO₂ – NH₃ cascade system is better compared with a traditional NH₃ system, when the refrigerant temperature is between -40°C and -54°C. Replacing big amounts of NH₃ in the plant with another refrigerant with less potential risk is another advantage of the system. NH₃ charge is reduced to the minimum and it is located only in the machinery room. This system is very suitable for new installations and particularly in applications for deep freezing where evaporating temperatures of -50°C are easily reached and thus decreasing freezing times or increasing the tonnage of frozen product.

NH₃-CO₂ pump circulation systems

In this system, the CO₂ is pumped to the evaporators where it is partially evaporated, the evaporated CO₂ is returned to the receiver and condensed in a heat exchanger which acts as the evaporator for the NH₃ side. These systems have a lot in common with systems using glycols or brine as secondary fluids to keep the ammonia in the plant room where it can be safely handled.

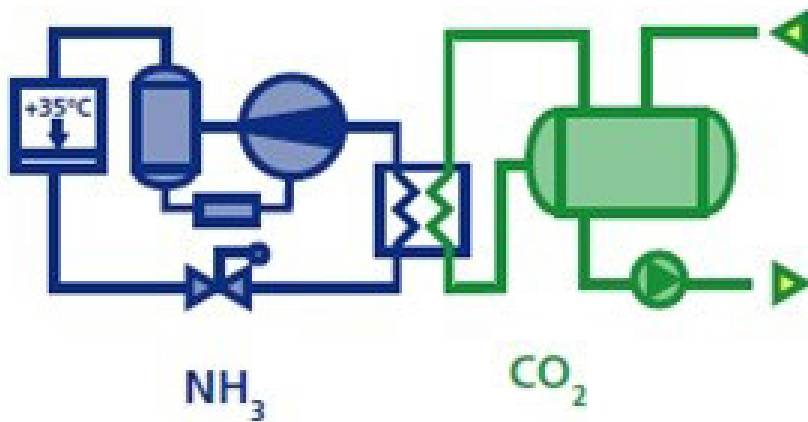

Figure 5.21 - CO₂ – NH₃ brine system

In these systems, the coolers have a very good heat transfer coefficient, as there is no oil present in the CO₂ side. Also, due to the great heat transfer of the CO₂, pipes and pumps are smaller and therefore have lower consumption than pumps for traditional brines. A CO₂ brine system is the best solution when there is already a CO₂-NH₃ cascade system and the plant is to be extended with

positive rooms, process areas, etc. It is also the case where low brine temperatures are necessary, as the high concentration of glycol could penalize efficiency. The CO₂ - NH₃ systems have some disadvantages and aspects to consider:

- ▶ In stand-still operation, saturated pressure can be very high, so it must be under control. A small separate refrigeration system is required to maintain saturated pressure under the design pressure during stand-still
- ▶ CO₂ hot gas defrost demands special attention, because of high defrosting pressures
- ▶ CO₂ replaces air and causes lack of oxygen so leakage detection systems are necessary.
- ▶ It is difficult to implement this solution in an existing brine refrigeration system because the high design pressure makes existing equipment no longer valid

The implementation of this strategy is always a challenge and only experimented companies should implement this solution. Due to the high CO₂ working pressures, very carefully designs must be realized and of course, attention must be paid to the special machinery to be used.

5.9.3 TECHNICAL REQUIREMENTS AND RECOMMENDATIONS

As the control strategy has a major influence on the refrigeration plant, it is essential to use the best possible control strategies, adapted to each refrigeration plant's demand.

Control strategies should be decided after analyzing the refrigeration plant's load demand curves.

This work should be performed by companies with experience in controlling and monitoring cooling and refrigeration plants. (for example Industrial Refrigeration Control System / IRC by ITCL).

5.9.4 ENERGY SAVING POTENTIAL

The next table shows the possible energy saving which could be achieved at refrigeration plants evaluated during the COOL-SAVE project, for different activities (NACE CODE) and different levels of annual energy consumption.

Table 5.35 - Examples: Optimize compressors' capacity control system

COMPANY	NACE CODE	Refrigeration plant annual consumption (kWh)	SAVING (EUR/YEAR)	ESTIMATED ENERGY SAVING kWh	% SAVING
Global		46.112.204	337.383 €	3.882.273	8,4%
N	NACE 103	1.261.669	1.141 €	12.617	1,0%
J	NACE 108	1.340.000	12.033 €	134.000	10,0%
I	NACE 102	1.384.710	636 €	7.062	0,5%
F	NACE 103	1.586.553	1.542 €	17.135	1,1%
G	NACE 102	1.799.242	1.781 €	19.792	1,1%
T	NACE 110	2.086.798	28.510 €	316.776	15,2%
D	NACE 105	2.335.000	- €	-	0,0%
S	NACE 107	3.205.862	4.616 €	51.294	1,6%
B	NACE 102	5.329.956	85.386 €	948.732	17,8%
X	NACE 101	7.673.863	72.932 €	810.360	10,6%
P	NACE 105	8.000.000	24.000 €	400.000	5,0%
M	NACE 101	10.108.550	104.805 €	1.164.505	11,5%

Table 5.36 - Examples: Improvement of condensers' efficiency - Optimize condensers' working sequences

COMPANY	NACE CODE	Refrigeration plant annual consumption (kWh)	SAVING (EUR/YEAR)	ESTIMATED ENERGY SAVING kWh	% SAVING
Global		32.634.683	77.775 €	739.231	2,3%
A	NACE 101	1.132.500	12.684 €	-	0,0%
I	NACE 102	1.384.710	23.629 €	262.541	19,0%
G	NACE 102	1.799.242	4.083 €	45.370	2,5%
U	NACE 105	2.000.000	2.160 €	40.000	2,0%
S	NACE 107	3.205.862	22.044 €	244.928	7,6%
B	NACE 102	5.329.956	- €	-	0,0%
X	NACE 101	7.673.863	8.081 €	89.784	1,2%
M	NACE 101	10.108.550	5.095 €	56.608	0,6%

Table 5.37 - Examples: Improvement of condensers' efficiency - Optimize the condenser control system

COMPANY	NACE CODE	Refrigeration plant annual consumption (kWh)	SAVING (EUR/YEAR)	ESTIMATED ENERGY SAVING kWh	% SAVING
Global		45.225.119	92.428 €	2.083.049	4,6%
W	NACE 101	35.258	507 €	5.631	16,0%
H	NACE 101	242.000	3.703 €	-	0,0%
R	NACE 105	694.000	6.983 €	81.200	11,7%
J	NACE 108	1.340.000	8.784 €	97.820	7,3%
V	NACE 104	1.428.000	12.852 €	-	0,0%
F	NACE 103	1.586.553	4.098 €	45.534	2,9%
G	NACE 102	1.799.242	122 €	1.354	0,1%
U	NACE 105	2.000.000	3.600 €	600.000	30,0%
D	NACE 105	2.335.000	2.831 €	24.300	1,0%
E	NACE 110	2.935.110	7.313 €	293.511	10,0%
B	NACE 102	5.329.956	- €	-	0,0%
P	NACE 105	8.000.000	27.000 €	800.000	10,0%
L	NACE 110	8.700.000	11.820 €	98.500	1,1%
K	NACE 110	8.800.000	2.816 €	35.200	0,4%

5.9.5 IMPLEMENTATION COST AND RETURN ON THE INVESTMENT

The following table shows the cost of the implementation of the strategy and the amount of money saved at refrigeration plants evaluated during the COOL-SAVE project for different activities (NACE CODE) and different levels of annual energy consumption.

The “return on investment” is also calculated for each refrigeration plant so the financial viability of implementing the strategy can be evaluated.

Table 5.38 - Examples: Optimize compressors' capacity control system

COMPANY	NACE CODE	Refrigeration plant annual consumption (kWh)	TOTAL STRATEGY COST	SAVING (EUR/YEAR)	ROI
Global		46.112.204	318.313 €	337.383 €	0,9
N	NACE 103	1.261.669	50.000 €	1.141 €	43,8
J	NACE 108	1.340.000	- €	12.033 €	-
I	NACE 102	1.384.710	12.000 €	636 €	18,9
F	NACE 103	1.586.553	11.013 €	1.542 €	7,1
G	NACE 102	1.799.242	12.000 €	1.781 €	6,7
T	NACE 110	2.086.798	27.000 €	28.510 €	0,9
D	NACE 105	2.335.000	16.100 €	- €	
S	NACE 107	3.205.862	15.000 €	4.616 €	3,2
B	NACE 102	5.329.956	27.000 €	85.386 €	0,3
X	NACE 101	7.673.863	37.500 €	72.932 €	0,5
P	NACE 105	8.000.000	15.300 €	24.000 €	0,6
M	NACE 101	10.108.550	95.400 €	104.805 €	0,9

Table 5.39 - Examples: Improvement of condensers' efficiency - Optimize condensers' working sequences

COMPANY	NACE CODE	Refrigeration plant annual consumption (kWh)	TOTAL STRATEGY COST	SAVING (EUR/YEAR)	ROI
Global		32.634.683	189.650 €	77.775 €	2,4
A	NACE 101	1.132.500	22.400 €	12.684 €	1,8
I	NACE 102	1.384.710	22.500 €	23.629 €	1,0
G	NACE 102	1.799.242	15.000 €	4.083 €	3,7
U	NACE 105	2.000.000	37.500 €	2.160 €	17,4
S	NACE 107	3.205.862	47.250 €	22.044 €	2,1
B	NACE 102	5.329.956	15.000 €	- €	
X	NACE 101	7.673.863	15.000 €	8.081 €	1,9
M	NACE 101	10.108.550	15.000 €	5.095 €	2,9

Table 5.40 - Examples: Improvement of condensers' efficiency - Optimize condenser control systems

COMPANY	NACE CODE	Refrigeration plant annual consumption (kWh)	TOTAL STRATEGY COST	SAVING (EUR/YEAR)	ROI
Global		45.225.119	203.486 €	92.428 €	2,2
W	NACE 101	35.258	2.000 €	507 €	3,9
H	NACE 101	242.000	20.736 €	3.703 €	5,6
R	NACE 105	694.000	- €	6.983 €	-
J	NACE 108	1.340.000	- €	8.784 €	-
V	NACE 104	1.428.000	37.500 €	12.852 €	2,9
F	NACE 103	1.586.553	12.000 €	4.098 €	2,9
G	NACE 102	1.799.242	4.050 €	122 €	33,2
U	NACE 105	2.000.000	8.250 €	3.600 €	2,3
D	NACE 105	2.335.000	14.100 €	2.831 €	5,0
E	NACE 110	2.935.110	29.400 €	7.313 €	4,0
B	NACE 102	5.329.956	15.000 €	- €	
P	NACE 105	8.000.000	34.850 €	27.000 €	1,3
L	NACE 110	8.700.000	8.700 €	11.820 €	0,7
K	NACE 110	8.800.000	16.900 €	2.816 €	6,0

5.10 LIST OF BEST SAVING STRATEGIES WITH LOWEST RETURN ON INVESTMENT (ROI)

Strategy description	Refrigeration plant annual consumption (kWh)	ROI	Strategy Cost	Estimated Energy saving (kWh)	Saving (EUR/year)
Installing a High Pressure Heat Pump	2.335.000	0,93	275.000€	2.549.000	296.959€
Optimized system control	6.022.009	0,53	27.892€	692.883	61.359€
Improvement of compressors efficiency - Optimize compressors working sequence	3.712.425	0,61	20.700€	491.740	44.257€
Improvement of compressors efficiency: Installation of variable speed devices (VSD)	10.108.550	0,95	36.450€	427.592	38.483€

Strategy description	Refrigeration plant annual consumption (kWh)	ROI	Strategy Cost	Estimated Energy saving (kWh)	Saving (EUR/year)
Optimize intermediate pressure set points and low pressure set points.	7.673.863	0,58	12.000€	229.449	20.650€
Implementing a Floating Head Pressure System	5.143.277	0,86	6.375€	72.017	7.959€
Improvement of cooling plant lines efficiency - Check valve replacement	5.329.956	0,34	1.620€	53.300	4.797€
Improvement of cooling plant lines efficiency - Optimize economizer expansion valve	1.586.553	0,70	2.363€	37.443	3.370€
Improvement in pumping system: - Optimize control of pump & temperature sensor	2.086.798	0,52	506€	10.851	977€

MAP OF EXISTING GRANTS SHOWING THE FUNDING OPPORTUNITIES AT NATIONAL LEVEL

6.1 COUNTRY OUTLOOK: SPAIN

6.1.1 CDTI TECHNOLOGY FUND

The Technology Fund is a special item in European Union FEDER funds allocated to promoting business R&D&I in Spain. The CDTI has been appointed to manage part of them for which different instruments with FEDER/CDTI joint financing have been designed in accordance with community requirements.

The Technology Fund is targeted at all Spanish regions, but in their distribution, priority has been given to former Objective 1 regions which, as a whole, are recipients of 90% of their budget:

- ▶ Andalusia, Extremadura, Castilla-La Mancha and Galicia: “Convergence” regions, recipients of 70% of the Technology Fund
- ▶ Autonomous region of Valencia, Castilla y León and the Canary Islands: “Phasing in” regions, recipients of 15%
- ▶ Murcia, Asturias, Ceuta y Melilla: “Phasing out” regions, recipients of 5%

The other Spanish regions (“Competitiveness” regions) are recipients of the remaining 10%.

6.1.2 FINANCING CHARACTERISTICS

The Technology Fund is mobilized through the financial instruments of the Centre and is assigned to the proposals submitted according to the availability of funds in the Autonomous Region where the project is to be developed. In [*Research and Development Projects \(PID\)*](#), joint financing with the Technology Fund gives the company an increase of 10 percentage points with respect to the non-refundable section of its proposal.

6.1.3 FEDER-INNTERCONECTA

The Technology Fund is also executed through a specific programme of subsidies via a call for applications (FEDER-Innterconecta) which supports integrated experimental development projects, of a large-scale, strategic nature, and whose objective is the development of new technologies in forward-looking technological areas with economic and commercial prospects at the international level.

6.1.4 INSTRUCTIONS FOR SUPPORTING PERSONNEL EXPENSES

If the CDTI funding, which the company is a beneficiary of, is financed using FEDER funds through the Technology Fund, your company is obliged to fulfil national and community regulations related to community funds included in the agreements signed by your company and CDTI and expenses for own personnel allocated to the project shall correspond to personnel registered in any job centre in the Autonomous Region where the project is undertaken.

Depending on which Autonomous Region the project is undertaken in, please take into consideration that, in order to be considered as eligible, the personnel expenses that you submit in the documents supporting your expenses shall correspond to the aforementioned Autonomous Region. The document substantiating such status is the TC2 for workers registered in the General Social Security System. Any expenses that do not fulfil this condition will not be considered as eligible and cannot be co-financed.

6.1.5 JESSICA - F.I.D.A.E. FUND

Investment Fund to finance energy efficiency projects and renewable energy. The Portfolio Fund by I.D.A.E. is a fund with about 123 M € which aims to finance sustainable urban development projects that improve energy efficiency, Renewable energy use and are developed by energy service companies (ESCOs) and other private companies.

It is co-financed by the ERDF Fund and IDAE and operated by the European Investment Bank (EIB). This fund will finance all investments directly related to the increase of energy efficiency and renewable energy use in urban environments and is compatible with other sources of public and private funding as well as grants co-financed by the ERDF or not.

For a project to be bankable, it must meet the following conditions:

- ▶ Being located in one of the 10 autonomous communities included in F.I.D.A.E.
- ▶ Being included in any of the following sectors:
 - ▶ Building: public buildings and private buildings
 - ▶ Industry: companies of any size
 - ▶ Transportation: infrastructure , equipment and fleets of private and public transport (for public use)
- ▶ Utility infrastructure related to energy:
 - ▶ Street lighting and traffic lights
 - ▶ Local infrastructure, including smart grids and information and communications technology (ICT)-related priority issues

Join one of the priority themes:

- ▶ Projects for Energy Efficiency and Energy Management:
 - ▶ Renovation of existing buildings, with performances in the thermal envelope, heating, cooling, lighting, etc..
 - ▶ New buildings with an A or B energy rating
 - ▶ Renewal or extension of heating or cooling networks exist
- ▶ Renewable Energy Projects
 - ▶ Solar thermal
 - ▶ Solar PV if they join a project of energy efficiency
 - ▶ Biomass

Projects related to clean transport which contribute to the improvement of energy efficiency and renewable energy use (electric charging infrastructure for electric vehicles or plug-in hybrid electrical energy recovery from braking electric public transport, fleet management, electric or hybrid buses, etc.).

- ▶ To ensure an acceptable return on investment
- ▶ To be included in integrated plans for sustainable urban development
- ▶ Not be finalized at the time of receiving funding

Investments made directly by IDAE therefore do not normally require disbursements by the final recipient of investment: it is not so much of a loan from the Industrial IDAE since the equipment is owned by the IDEA until you

recover the investment. So with this form of action, the industry maintains full debt capacity and its own resources that can be allocated to other purposes within the company.

IDAE recovers its investment, including profit, by the energy saved or generated energy. Thus, the user of the installation experiences a decrease in their energy costs from the outset.

6.1.6 OTHER GRANTS

The IDAE provides direct funding that can be refunded through the Autonomous Communities (CCAA), to some kind of investments in certain types of projects that promote energy efficiency or drive renewable energy. These funds include those that are part of the 2005-2010 Renewable Energy Plan (PER) and the 2008-2012 Action Plan Strategy and Efficiency Savings in Spain (E4) and jointly managed with CCAA, via agreements established between IDAE and each Autonomous Community. The respective Autonomous Communities are responsible for the development of public aid programs, preparation and call for regulatory bases, management, processing and technical assessment records, resolution of such aid, certification and payment of the sums, including the controls, and, where appropriate, the reinstatement and punitive measures.

6.2 COUNTRY OUTLOOK: HUNGARY

6.2.1 HUNGARIAN ENERGY STRATEGY 2030 PRIORITIES

The major actions listed in the Parliamentary Decision with regard to the objectives of the Energy Strategy are as follows:

- ▶ Framing the Act on sustainable energy management
- ▶ Improving energy efficiency:
 - ▶ National Energy Efficiency Action Plan
 - ▶ Energy Strategy for the Building Sector
 - ▶ Power Plant Development Action Plan

- ▶ Increasing the utilisation of renewable energies:
 - ▶ Hungary's Renewable Energy Action Plan
 - ▶ Regional mapping of the renewable energy potential
- ▶ Transport development:
 - ▶ Zero Carbon Transport Concept
- ▶ Utilisation of domestic fuel resources:
 - ▶ Reserve management and utilisation action plan
- ▶ Environmental awareness-raising:
 - ▶ Awareness-Raising Action Plan
 - ▶ Establishment of a network of energy engineers
- ▶ Achieving industry development objectives:
 - ▶ Energy industry development and R&D&I Action Plan
- ▶ Ensuring the competitiveness of the district heating service:
 - ▶ District Heating Development Action Plan

6.2.2 THE EUROPEAN AGRICULTURAL FUND FOR RURAL DEVELOPMENT

In all economic sectors, smart and sustainable growth is needed to manage scarce resources. Agriculture must use energy and water more efficiently (farms account for about 24% of total EU water use) while cutting its greenhouse gas emissions and sequestering carbon. Farming and other rural sectors can supply essential raw materials for use in the bio-economy.

Areas of intervention (Focus areas):

- ▶ Increasing efficiency in water use by agriculture
- ▶ Increasing efficiency in energy use in agriculture and food processing
- ▶ Facilitating the supply and use of renewable sources of energy, by-products, wastes, residues and other non-food raw materials for the bio-economy
- ▶ Reducing nitrous oxide and methane emissions from agriculture
- ▶ Fostering carbon sequestration in agriculture and forestry

Within the Új Széchenyi Terv (<http://www.ujszechenyiterv.hu/>) and the Darányi Ignác Terv (<http://www.umvp.eu/category/tagek/daranyi-ignac-terv>) 7080 billion HUF will be available in the Hungarian economy, most of the calls for proposals will be made public in the second period of 2014.

6.2.3 OPEN CALLS FOR PROPOSALS IN HUNGARY

6.2.3.1 Közép-Dunántúli Operatív Program, Industry building component, Identification number: KDOP-1.1.1/D-13

<http://palyazatmenedzser.hu/2014/01/05/ipartelepites-kdop-111d13/>

- ▶ For reconstruction, extension, modernization, renovation of existing buildings, the necessary plumbing investments
- ▶ The amount of aid:
 - ▶ Minimum: 100 million HUF,
 - ▶ Maximum: 1000 million HUF
- ▶ Submission of proposals: from 6th January 2014

6.2.3.2 KIC INNOENERGY Call for Innovation Proposals 2014-2

<http://cip2014.kic-innoenergy.com/>

KIC InnoEnergy is an organisation that brings together education, research and industry to boost sustainable energy and related technology innovations across Europe. We support research institutions, companies and universities with the last stage of the go-to-market process for innovative sustainable energy products and services. We help organisations to create public-private consortia that have the ability to take high-potential ideas to the market faster and more effectively, and offer significant financing schemes. Our partnership approach is specifically geared at developing lab ideas in order to launch them into markets as viable commercial products. We will assist you in finding the right partners for the creation of your product or service. KIC InnoEnergy is funded by the European Institute of Innovation and Technology (EIT) with 27 shareholders, all of whom are key players within the energy field, from top rank of industries, research centers and universities. It provides the protection you need against the usual barriers such as IP protection, relevant expertise from partners, talent poaching or lack of test processes.

Benefits of participation:

- ▶ Stable collaboration, business-oriented framework for open innovation
- ▶ European partnership specialised in sustainable energy, involving top actors in the field
- ▶ First customer for your product within our European network

- ▶ Clear IP rules and other business support mechanisms
- ▶ Flexible & professional management programme
- ▶ Technology improvement and access to new technologies
- ▶ Access to new markets
- ▶ Faster go-to-market process
- ▶ Substantial KIC InnoEnergy funding, that hedges the risk of your investment

KIC InnoEnergy innovation projects are open to public-private consortia which currently have an innovative technology project and are looking to accelerate the deployment of their lab idea into a marketable product.

6.2.3.3 Open calls in Új Széchenyi Terv

There are some open calls for SMEs within Új Széchenyi Terv for purchasing of equipment and for technological development.

<http://www.ujszecenyiterv.hu/palyazat/vallalkozasfejlesztési-program/mikro-es-kis-es-kozepvallalkozások-technologia-fejlesztése.php>

<http://www.ujszecenyiterv.hu/palyazat/vallalkozasfejlesztési-program/komplex-vallalati-technologia-fejlesztés-mikro-kis-es-kozepvallalkozások-számára-kozep-magyarországi-regioban.php>

<http://www.ujszecenyiterv.hu/palyazat/vallalkozasfejlesztési-program/komplex-vallalati-technologia-fejlesztés-mikro-kis-es-kozepvallalkozások-számára-khg-kmr.php>

<http://www.ujszecenyiterv.hu/palyazat/vallalkozasfejlesztési-program/komplex-vallalati-technologia-fejlesztés-mikro-kis-es-kozepvallalkozások-számára.php>

<http://www.ujszecenyiterv.hu/palyazat/vallalkozasfejlesztési-program/komplex-technologia-fejlesztés-es-foglalkoztatás-támogatása.php>

<http://www.ujszecenyiterv.hu/palyazat/vallalkozasfejlesztési-program/az-üzleti-infrastruktúra-es-a-befektetési-környezet-fejlesztése-eszak-magyarországi-regioban.php>

6.3 COUNTRY OUTLOOK: UNITED KINGDOM

6.3.1 UK NATIONAL ENERGY EFFICIENCY ACTION PLAN 2014 TO 2015

The UK Government has introduced a wide range of policies to help households, businesses and the public sector reduce their energy use. These policies are working. Energy consumption in the UK has fallen for eight of the last nine years and final energy consumption is now 13% lower than in 2003. Moreover, energy consumption is now falling in all sectors of the UK economy.

The UK's declining energy consumption reflects our international leadership on energy efficiency; the UK now has the least energy intensive economy in the G8.

6.3.2 DEPARTMENT OF ENERGY & CLIMATE CHANGE (DECC)

The Department of Energy and Climate Change was created in 2008 to bring climate change and energy policy into one department. The energy sector is a critical part of the UK economy and is an important driver of growth. They must ensure UK energy security, so consumers have access to the energy they need for light and power, heat and transport at affordable prices.

The DECC works to make sure the UK has secure, clean, affordable energy supplies and promote international action to mitigate climate change.

They are responsible for:

- ▶ energy security – making sure UK businesses and households have secure supplies of energy for light and power, heat and transport,
- ▶ action on climate change – leading government efforts to mitigate climate change, both through international action and cutting UK greenhouse gas emissions by at least 80% by 2050 (including by sourcing at least 15% of our energy from renewable sources by 2020),
- ▶ renewable energy – sourcing at least 15% of our energy from renewable sources by 2020,
- ▶ affordability – delivering secure, low-carbon energy at the least cost to consumers, taxpayers and the economy,

- ▶ fairness – making sure the costs and benefits of our policies are distributed fairly so that we protect the most vulnerable and fuel poor households and address competitiveness problems faced by energy intensive industries,
- ▶ supporting growth – delivering our policies in a way that maximises the benefits to the economy in terms of jobs, growth and investment, including by making the most of our existing oil and gas reserves and seizing the opportunities presented by the rise of the global green economy,
- ▶ managing the UK’s energy legacy safely, securely and cost effectively

Their priorities are:

- ▶ supporting investment in the UK’s energy infrastructure – including through the Energy Bill, which will set in place the framework to bring forward the £110 billion needed in our electricity infrastructure over the next decade,
- ▶ supporting consumers and keeping energy bills down, including through implementation of the Green Deal,
- ▶ promoting action in the EU and internationally to maintain energy security and mitigate dangerous climate change as we chart the way towards a global deal on climate change in 2015.

6.3.3 ENERGY RELATED FUNDS AND INITIATIVES IN THE UNITED KINGDOM

Community Energy: <https://www.gov.uk/community-energy>

Community energy covers aspects of collective action to reduce, purchase, manage and generate energy. Community energy projects have an emphasis on local engagement, local leadership and control and the local community benefiting collectively from the outcomes.

Community-led action can often tackle challenging issues around energy, with community groups well placed to understand their local areas and to bring people together with common purpose.

There are many examples of community energy projects across the UK, with at least 5000 community groups undertaking energy initiatives in the last five years.

6.3.3.1 Community Electricity and Heat Generation

Community electricity or heat generation can enable communities to benefit from local resources. Renewable electricity and heat generation contribute to the UK's goal of reducing greenhouse gas emissions, helping your community play a part in reducing climate change. Your community may be able to receive a financial benefit from electricity and heat generation, in addition to other benefits, such as bringing everyone together or engaging people with ideas on how to save energy or money on energy bills.

Feed-in Tariffs (FITs) scheme

FITs support individuals and organisations, including communities, to generate low-carbon electricity using small-scale systems. The scheme covers solar PV panels, wind turbines, water turbines, anaerobic digestion (biogas energy) and micro combined heat and power (micro-CHP).

The Renewable Heat Incentive (RHI) Scheme

The RHI helps organisations including communities to meet the cost of installing renewable heat technologies. The scheme covers biomass, ground and water source heat pumps, geothermal, solar thermal, biomethane and biogas heating.

6.3.3.2 Heat Networks Delivery Unit

The Heat Networks Delivery Unit (HNDU) was established in September 2013, in response to a commitment in 'The future of heating: meeting the challenge' (published in March 2013). HNDU will provide grant funding and guidance to local authorities in England and Wales to explore heat network opportunities until March 2015. Local authorities apply for HNDU support through bidding rounds, with around 50 applications received in the three rounds to date. All bids are reviewed by a panel of engineering, financial and commercial experts with significant experience in heat networks development. HNDU grant funding of no more than 67% of eligible costs is provided to successful local authorities under section 31 of the Local Government Act. HNDU define eligible costs as external commissioned consultancy costs for heat network development work; heat mapping, master planning, feasibility studies and detailed project development.

Since its inception in September 2014, the Unit has awarded support to 122 projects in 91 local authorities and has awarded just under £9 million of grant funding. Round 4 opens on 16th October and close on 27th November 2014.

6.3.3.3 £15m Rural Community Energy Fund (RCEF) - open to applications

The £15m RCEF is aimed at helping rural communities in England access funding to carry out feasibility studies for renewable energy projects, fund pre-planning studies and preparation of planning applications. RCEF funds will support eligible rural projects including wind, solar, biomass, heat pumps, anaerobic digestion, gas Combined Heat and Power (CHP) and hydro through initial grants at stage 1 (less than £20,000) and loans at stage 2.

6.3.3.4 Urban Community Energy Fund

<https://www.gov.uk/urban-community-energy-fund>

The Urban Community Energy Fund (UCEF) is a £10m fund to kick-start renewable energy generation projects in urban communities across England. Community groups will be able to access grants and loans to support renewable energy developments.

Grants of up to £20,000 are available for the more speculative, early stages of your project's development, such as public consultation and preliminary viability studies.

UCEF will also provide loans of up to £130,000 to develop planning applications and a robust business case to attract further investment. This will help your project become 'investment ready', that is, at the right stage to secure a bank loan or another form of investment.

The technologies that will be considered under UCEF include the following:

- ▶ wind turbines
- ▶ hydropower
- ▶ solar photo voltaic
- ▶ solar thermal
- ▶ ground, water and air source heat pumps
- ▶ anaerobic digestion
- ▶ biomass
- ▶ low carbon/renewable heat networks
- ▶ gas combined heat and power (CHP) units

6.3.4 OTHER FUNDINGS AND INITIATIVES

6.3.4.1 VAT for builders

<https://www.gov.uk/vat-builders/energy-mobility>

Energy saving and mobility aids

You may be able to charge the reduced rate of VAT (5%) for work in residential properties to install:

- ▶ certain energy-saving, heating and security products
- ▶ mobility aids for people over 60

This includes the cost of the products themselves if you install them - but if you only supply them you must charge the standard rate of 20%.

Energy saving, heating and security

You can charge the reduced rate of VAT on work you do to install qualifying energy-saving products, and certain grant-funded heating and security equipment for people over 60 or on benefits. You can also charge the reduced rate for extra work you need to do as part of the installation. But you must charge the standard rate of 20% on all work if the installation is just part of another, bigger job.

Examples:

- ▶ you have to cut a new hatch in the ceiling to install loft insulation. Because you needed to do this as part of the insulation, you can charge reduced-rate VAT
- ▶ you replace a roof with a new, insulated one. Because the insulation is just part of a bigger job, you have to charge the standard rate of 20% on the whole job

6.3.4.2 UK funded projects and opportunities

Examples of existing private sector projects that are funded by the International Climate Fund:

Climate Public Private Partnership (CP3)

The Department of Energy & Climate Change and the Department for International Development will invest £130 million in 2 commercial private equity funds, which will aim to leverage private co-investment. These funds will be run on a strictly commercial basis by professional fund managers.

As well as an equity investment of £110 million, the project will include technical assistance to support the development of the project pipeline and facilitate pioneering projects.

Partnership for Market Readiness (PMR)

The Department of Energy & Climate Change (DECC) has given £7 million to the PMR, which is a grant-based trust fund that helps middle-income countries develop and pilot market-based policies to reduce greenhouse gas emissions.

The PMR brings together policy makers from governments with experts and stakeholders to provide a platform for piloting these market-based policies. It builds on developing countries' own mitigation priorities and recipient countries include Chile, Colombia, Costa Rica, Mexico, China, Indonesia, Thailand, Turkey and the Ukraine.

GAP

The Department for International Development (DFID) produces a monthly Sustainable Energy Newsletter. It highlights new funding opportunities, events and research surrounding renewable energy, resource efficiency and low carbon development.

6.3.4.3 Energy Entrepreneurs Fund

<https://www.gov.uk/government/collections/energy-entrepreneurs-fund>

This is a competitive funding scheme to support the development and demonstration of state of the art technologies, products and processes in the areas of energy efficiency, power generation and heat and electricity storage.

The Energy Entrepreneurs Fund seeks the best ideas, irrespective of source, across these energy technology areas from the public and private sector. The scheme particularly aims to assist small- and medium-sized enterprises, including start-ups, and those companies that are selected will receive additional funding for incubation support.

Phase 3 (<https://www.gov.uk/government/publications/energy-entrepreneurs-fund-phase-3-documents>)

The remaining £10m is now available for projects up to March 31st 2016. Full details on how to apply, and deadlines for registration and submission of applications, is in the guidance notes.

During the application process, applicants will be expected to demonstrate a robust evidence based case for funding, that will include but not be limited to:

- ▶ the potential impact of the innovation on 2020 and/or 2050 low carbon targets or security of supply
- ▶ the technical viability of their innovation and coherent development plan that will commercially progress the innovation
- ▶ value for money
- ▶ the size and nature of the business opportunity

6.3.4.4 Innovation: apply for a funding award

<https://www.gov.uk/innovation-apply-for-a-funding-award>

If you want to develop an innovative product or service, you may be able to apply for funding of between £5,000 and £10 million.

Innovate UK runs funding competitions which can help you develop your idea and make it successful. These competitions are open to all UK based companies. Some are also open to research organisations working with business. Innovate UK awards funding to the winners of these competitions.

Relevant areas:

- ▶ Built environment - energy eco-systems; energy management and diagnostics tools
- ▶ Energy - developing new energy technologies; building a flexible, secure and resilient energy system; reducing greenhouse gas emissions at point of use

6.3.4.5 Delivering economic benefit through the development of low carbon, low emission automotive propulsion technologies (competition 3)

The Advanced Propulsion Centre (APC), in partnership with the Department for Business, Innovation and Skills (BIS) and Innovate UK is to invest up to £100m in collaborative research and development funding to support the development of low carbon, low emission automotive propulsion technologies.

Projects must demonstrate technologies that:

- ▶ deliver significant reductions in vehicle CO₂ or other emissions compared to current best-in-class technologies

- ▶ align with Automotive Council Technology Group roadmaps with respect to advanced propulsion solutions
- ▶ develop the UK's supply chain in the field of low carbon vehicle propulsion technology

Projects must be collaborative and business-led and include a vehicle manufacturer or a tier 1 supplier and an SME partner.

Overall, each project should aim to attract no more than 50% public funding of the total eligible project costs.

We expect to fund mainly industrial research, in which a business partner will generally attract up to 50% public funding for their project costs (60% for SMEs), or experimental development, with a business partner attracting 25% funding (35% for a SME). We expect total eligible project costs to be between £5m and £40m. Projects are expected to last between 18 and 42 months.

6.4 COUNTRY OUTLOOK: FRANCE

6.4.1 FINANCING SYSTEMS

Numerous funding mechanisms exist in France for financing food companies' energy savings projects. Funding schemes include:

- ▶ investment aid
- ▶ certificate of energy savings ("Certificat d'économie d'énergie")
- ▶ loans
- ▶ calls for expression of interest and financial support through calls for proposals

6.4.2 INVESTMENT AID

The French State and ADEME (French Environment and Energy Management Agency) provide financial support principally for investments in equipment for preventing and reducing energy consumption. To this aim, training and pedagogical tools can also be proposed by:

- ▶ professional federations
- ▶ ADEME
- ▶ private professional training organisations

In 2014, The French Environment and Energy Efficiency Agency proposes several types of financial support, including investment aid to food companies (under certain conditions), for investment in new equipment used in production, distribution, or energy use, and for upgrading existing equipment to improve its energy efficiency. These financial support measures cannot be aggregated with the “Energy Savings Certificate” scheme (c.f. below).

The French State and the French Regions also propose financial aid for investments. At the regional level, numerous funding schemes exist, differing from one region to another. The regions often co-finance projects with ADEME, with BPIFrance (French Public Investment Bank), with the EU, and sometimes with private companies. Among these tools available for the agricultural and food sector, those concerning more specifically food businesses include calls for proposals for investments, with funding from earmarked funds in the Future Investments Program (“Programme des Investissements d’Avenir”) and the Heat Fund (“Fonds Chaleur”).

6.4.3 ENERGY SAVINGS CERTIFICATE SCHEME (“CERTIFICATS D’ECONOMIES D’ENERGIE”)

The Energy Savings Certificate Scheme (ESC ; “Certificats d’Economies d’Energie”) was created in 2006 in the aim of achieving energy savings in all sectors (building, industry, transports and agriculture). The scheme is based on an obligation which is imposed by public authorities on energy providers and which obliges them to implement programmes that encourage their clients to invest in energy savings. There is a financial penalty that energy providers have to pay if they do not implement these actions and fulfil their obligations within the allotted timeframe.

Approximately 2000 energy providers (electricity, gas, urban heating, domestic fuel and carburants...) are subject to this obligation, and have quotas to fulfil proportional to their energy sales. They must carry out programmes which incite their clients to undertake actions to realize energy savings. Other actors in the field who are not subject to this obligation can carry out these types actions and and can valorize them by selling the obtained certificates to the actors subject to the obligation.

A multiannual objective corresponding to a reference period (e.g. 2011-2014) is defined for the country and distributed between the energy providers according

to their sales volumes. At the end of the reference period, the operators must demonstrate that they have achieved their objectives by detaining a number of Energy Savings Certificates equivalent to their level of obligations.

These certificates are obtained either through actions implemented by the energy suppliers themselves or by other eligible actors who then sell the certificates to the energy suppliers. In case of non obtention of the required number of certificates, energy providers must pay a penalty fee.

The three methods of awarding the ESCs are:

- ▶ energy users (clients) carrying out standardized energy savings operations, accompanied by energy suppliers. The eligible actions are listed in a decree issued by the Minister for the Environment in the form of a catalogue of technical sheets
- ▶ energy users carrying out “specific energy savings operations” (energy savings operations not included in the catalogue of technical sheets), accompanied by other eligible actors (other than the energy providers)
- ▶ contributing to energy savings programmes targeting the most disadvantaged households or to programmes of accompanying measures on the following themes: information and innovation in favour of energy consumption management (also defined in a decree issued by the Minister for the Environment)

These measures are evolutive and can be reviewed and complemented. It should be noted that Energy Savings Certificates and Investment Aid by the French Environment and Energy Agency cannot be aggregated.

Examples of eligible standardized operations:

- ▶ heat recovery on a cooling system
- ▶ installing a performant evaporator
- ▶ putting in place an energy management system within the company
- ▶ installing a pre-cooler for milk
- ▶ installing a high-performance isolating door for vertical freezers for frozen products
- ▶ training programmes in the field of energy efficiency

6.4.4 LOANS

Loans for energy efficiency measures can be granted at several levels: the Regions, BPIFrance (Public Investment Bank)... One example of a loan for energy efficiency measures is the Loan for Energy Savings (“Pret Eco-Energie”) granted by BPIFrance. This is a subsidized loan, subsidized by the French State, and can be used to finance investments in equipment allowing to improve energy efficiency and any related renovations. Recipients of this type of loan benefit from a subsidized interest rate. Cooling equipments are eligible, e.g. vertical refrigeration appliances with specific lighting systems.

6.4.5 CALLS FOR EXPRESSION OF INTEREST AND FINANCIAL SUPPORT THROUGH CALLS FOR PROPOSALS

Calls for expressions of interest and calls for proposals require companies desiring to participate in furthering science and innovation in the field of energy efficiency to develop projects that could further technology or techniques, be it at an experimental stage or at the industrial development stage. The French State has structured its calls for expression of interest in a programme, the Investments for the Future Programme (“Programme des Investissements d’Avenir”). Its operational management is delegated to 10 different public bodies, including the aforementioned BPIFrance and ADEME, and others. These calls for expression of interest aim at identifying projects with a high added value for the French economy, and potential participants may apply either alone, or as part of a consortium. The specifications of these calls tend to favour collaborative projects. Financing can be provided through venture capital, grants, or loans. The State thus takes on a role as an investor. Calls for proposals of the French State principally aim at providing support for collaborative R&D projects aiming at solving technical problems, including in the cooling sector. The State intervenes either through grants or through repayable advances, depending on the level of risk involved in the project. SMEs can benefit from calls for proposals.

Examples of actions include:

- ▶ The French Environment and Energy Agency Investment Fund, which finances e.g. “intelligent electrical circuits” and “financing the energy and ecological transition”

- ▶ The Ecotechnology Fund, managed by the Public Investment Bank, which finances e.g. loans for “Green growth”, “reindustrialisation”, as well as collaborative projects working on key enabling technologies, potentially also in the cooling sector. Financing mainly occurs through minor State participation, and covers subjects such as ecoconception and smart grids.
- ▶ The Caisse des Dépôts public group serving the general interest and economic development (Deposit and Loans Fund) finances a programme for company energy efficiency (“Programme de Financement de l’Efficacité Energétique des Entreprises”). This program is under development and should allow companies to make investments in the field of energy efficiency without cost to companies. These funds should be available through a Factory of the future (“Usine du Futur”) programme, which is part of a governmental plan for a “New Industrialized France”, aiming at reviving the industrial sector in France and boosting its competitiveness.

6.5 COUNTRY OUTLOOK: ITALY

6.5.1 ENERGY DEMAND

If compared to other EU Member States, Italy’s energy need is characterized by more vulnerable supplies, higher dependence on hydrocarbons (oil and gas), a limited carbon contribution and the total lack of electronuclear generation. The primary energy demand, in 2012, was of the order of 176.3 Mtep, i.e., 2.7% lower than in 2011.

6.5.2 FINAL ENERGY CONSUMPTION

In 2012, the final energy consumption was 127.9 Mtep, 5.2% less than 2011. Traditionally, Italy is one of the most energy-efficient countries among the industrialized ones: the final energy consumption per capita of 2.4 tep/capita is actually one of the lowest among the countries with similar industrial development.

6.5.3 USE OF ENERGY IN THE AGRO-FOOD SECTOR

The agro-food sector includes agriculture (primary production that provides the raw materials), the food industry that operates processing and agro-processing sector and the distribution of the final products to consumers. The amount of fossil energy consumed for production of foodstuffs and vegetables (vegetables, fruits, etc.), meat products (meat, sausages, etc.) and dairy (mozzarella, cheese) is remarkable: for 2012 were estimated at 16.31 Mtoe of final energy consumption for the entire agro-food sector, of which 2.8 Mtoe attributable to the agriculture sector.

Referring to the fruit and vegetable products, the food industry consumes electricity and heat for the processing (processing), in particular for the chemical-physical treatments of the products, as well as for packaging and for storage at temperatures suitable to maintain the quality of fruit and vegetables over the cold chain. Smil calculated that the energy consumption for the maintenance of food products, particularly for the operations of freezing, required 1-3 MJ/kg of the product ready for the market. **In general, half of the final energy consumption is involved in the interventions of heating, cooling, drying, chilling and freezing**, sterilization and sanitization, i.e. for the processing of primary products, while 10% of the final energy required for air conditioning of industrial buildings, transport and domestic services. In Italy, it is estimated that the final energy consumption of the food industry is 60% due to electricity consumption and 40% due to the consumption of thermal energy, the latter due, in large part, to the processes of production **requiring pasteurization and sterilization** of the products.

6.5.4 REVIEW OF THE ITALIAN INSTRUMENTS TO IMPROVE ENERGY EFFICIENCY

The instruments to improve energy efficiency which are already in force are included in one of the following categories:

6.5.4.1 *Legislative/Normative Instruments*

The most important funding opportunities and incentives for SMEs derives from the periodical tender issued by the Ministry for Economic Development.

For example:

New Law Sabatini Bis (Art. 2 Decree-Law n° 69/2013)

This instrument is aimed at SMEs who invest (including through financial leases) in machinery, equipment, capital goods and business equipment, new factories, as well as investments in hardware, software and digital technologies. The measure provides for the establishment of a ceiling of resources that banks can use to grant loans of between 20,000 and 2,000,000 Euros. The initiative also includes a grant from the Ministry of Economic Development of a fee which covers part of the interest paid by firms on bank loans.

6.5.4.2 R&D grants

Government investment policies or support to investments in technology research, development and demonstration.

Decree on sustainable industry (Decree-Ministry 15 October 2014)

Investments should cover R&D industrial activities, aimed at realising new products, processes, services, product refining which will lead to concrete achievements under several topics such as industrial technologies, energy technologies and environmental technologies.

Projects shall:

- ▶ include eligible costs not lower than 5 mln € and not higher than 40 mln €
- ▶ start not more than 3 months after the Decree of Grant
- ▶ last not more than 36 months
- ▶ if presented by a consortium of partners, each one must incur at least 10% of the total eligible costs

Energy efficiency convergence objective regions tender

The Ministry of Economic Development, through the Ministerial Decree of 5 December 2013 introduced a tender on the funding of integrated programs of investment aimed at reducing and rationalizing the use of primary energy used in existing productive units and localized in the convergence regions (Calabria, Campania, Puglia and Sicily). The fund has an overall ceiling of EUR 100 million that will be used to grant subsidized loans without interest of between 30,000 and 3,000,000 Euros, with coverage up to 75% of the eligible cost.

6.5.4.3 Financial Incentives and Subsidies

Measures encouraging or fostering given activities, behaviours or investments by using financial and fiscal instruments. These include incentives for renewable energy, discounts for high-efficiency domestic appliances, subsidies, subsidized loans and forms of financing. In addition, fiscal incentives are provided, such as tax exemptions, reductions and/or credits to purchase or install given services and goods.

Cassa depositi e prestiti (cash deposits and loans)

This public institution can support PMI growth, efficiency and internationalisation. For example, the Plafond Capital goods: conveyed through the credit channel, is targeted at SMEs operating in all productive sectors who invest (including through financial lease transactions) in machinery, equipment, capital goods and business equipment, new factories, as well as investments in hardware, software and digital technologies.

6.5.4.4 White certificates (WCs)

They derived from energy saving or obligations and green certification systems based on the obligation to produce or purchase a minimum amount of renewable energy (mainly electric power). White certificates, also known as “Energy Efficiency Certificates” (TEE), are securities that certify the achievement of energy savings in end-use of energy through actions and projects to increase energy efficiency. The white certificate system was introduced in Italian legislation by the Ministerial Decrees of 20 July 2004 and subsequent amendments and provides that distributors of electricity and natural gas annually are to reach certain goal quantities of primary energy savings, expressed in tons of oil equivalents saved (TEP). A certificate is equivalent to saving a ton of oil equivalent (TOE). The obligations set, associated with the energy savings resulting from interventions since the mechanism will allow a reduction of primary energy by about 25 Mtoe, in the four years from 2013 to 2016, and a reduction in CO₂ emissions of 15 million metric tons per year.

The mechanism introduces a package of measures to facilitate the implementation of new energy efficiency projects. These include the simplification of the access mechanism, the approval of 18 new cards for the evaluation of the savings in the industrial, civil and transport, the simplification of the process of preparation of the new cards, the inclusion of new areas of intervention, the

expansion of the entities that can submit projects. In order to stimulate the construction of large projects, industrial and infrastructure, capable of generating significant volumes of savings, there are more incentives for investments made.

6.5.5 MORE LINKS

www.enea.it

www.gse.it

www.cdp.it

www.fire.it

<http://www.sviluppoeconomico.gov.it/index.php/it/energia/efficienza-energetica>

6.6 COUNTRY OUTLOOK: BELGIUM

6.6.1 FINANCING SYSTEMS

In Belgium, there are several funding programmes for energy savings. Belgium has two distinct funding systems – one for French-speaking Wallonia and one for Flemish-speaking Flanders. The corresponding webpages are not available in English. For Flanders, the energy savings funding systems focused specifically on cooling can be found at www.agentschapondernemen.be. The “Ecologiepremie Plus” funding programme grants subsidies, via calls for proposals, to companies that invest in some specific technologies, listed in a document, among others cooling systems.

This exhaustive list of technologies eligible for funding with the ecology premium was trimmed down to 30 technologies in 2014. The chosen selection contains the most efficient technologies and the technologies that contribute most to the achievement of the Kyoto commitments, the European 20/20/20 targets and the Flemish environmental objectives. The new technologies list will apply to aid applications submitted from November 17, 2014. Among these technologies, a short example is provided hereafter: T1301 A new cooling system based on alternative refrigerants (other than ammonia: a new cooling system for cooling spaces, products or process streams based on CO₂, air, non-gehal eyes hydrocarbons such as propane, (iso) butane, propylene, ethylene, ethane. A new cooling system based on ammonia is shown in T 1301.

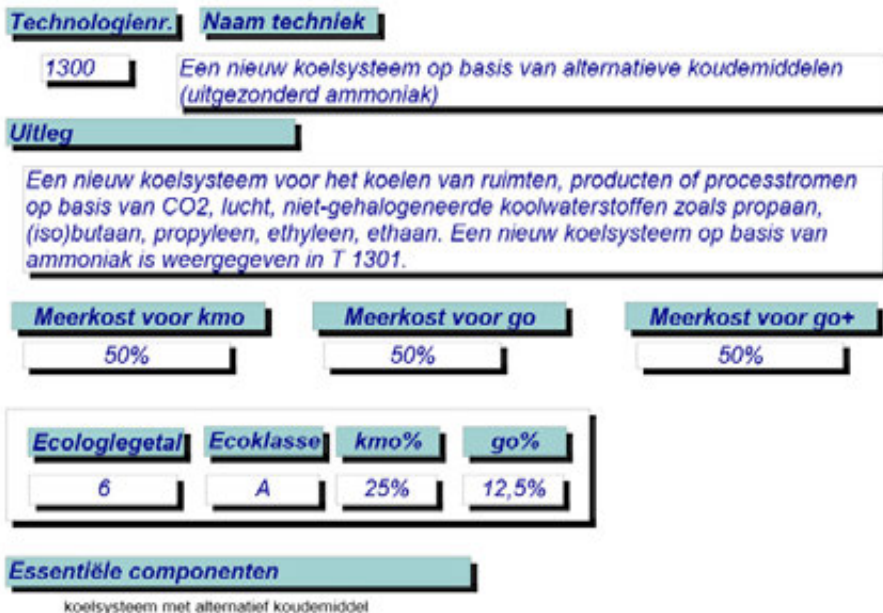

Figure 6.1 - Example : a new cooling system based on alternative refrigerants (other than ammonia)

These grants are very highly by companies, and the Flemish government was obliged to reduce the rates of assistance mid-2014, otherwise budgets would have been completely depleted by summer. The federal government in Wallonia principally grants funding in the field of relighting of industrial installations (and offices, retail...) for less energy-consuming lighting systems:

<http://energie.wallonie.be/fr/index.html?IDC=6018>

<http://www.ellipse-ise.eu/wp-content/uploads/2014/05/Plan-national-2014-Belgique-Wallonie.pdf>

Some programs also exist for other energy efficiency measures, such as the **AMURE program**, which allocates grants to the industrial sector for energy efficiency audits. These audits must be carried out by an expert who is certified by the federal government of Wallonia. The objective of this program is to allow companies to evaluate the pertinence (or non pertinence) of investment aiming to rationalize energy consumption. The PAEE094 grant is specific to

optimizing cooling systems in the industry (not including buildings). Fiscal deduction measures also exist, and the federal government in Wallonia grants the corresponding fiscal certificates.

6.7 COUNTRY OUTLOOK: GERMANY

6.7.1 INDUSTRY AND TERTIARY SECTOR

Starting in February 2008, the Federal Ministry for Economics and Technology (BMWi) together with the KfW promotional bank offer a special fund for energy efficiency in SMEs in order to promote energy efficiency in small and medium enterprises. On the one hand, the fund supports the advice on potential energy savings in SMEs providing a grant of up to 80 % for independent energy advice. On the other hand, financial support is given for investments (in the case of replacement investments leading to an energy saving of a minimum of 20% compared to the average consumption of the last three years and new investments leading to energy savings of at least 15% compared to the branch average) for exploiting the saving potentials by means of low-interest loans within the ERP Energy Saving Programme. Both of those components can be taken advantage of separately.

One measure in the Energy Concept from 2010 was the creation of an “Energy and Climate Fund” by law, out of which both a special energy efficiency fund was established and the financing for the existing National Climate Initiative was increased. Both initiatives shall initiate important efficiency measures at all levels - municipalities, industry, SMEs and consumers. The funding provided for the energy efficiency fund was around 100m € for 2011 and 2012 and an increase to a maximum of 300m € in 2015.

From 2012, the whole Energy and Climate Fund should be financed only by revenues from ETS. Due to the very low prices for CO₂ at the moment, the financing of this fund is not stable. With regard to product labelling and standards, Germany is advocating ambitious standards at the EU level and transparent labelling for cars, products and buildings. In order to save electricity, the advisory service for private consumers was considerably extended, especially for poor households. In industry, a wider spread of energy management systems and energy audits is supported in order to help industry to better identify and tap its efficiency potential. In the course of reorganization of the eco-tax relief to

energy-intensive companies, this requirement is to be linked to the operation of energy management systems in accordance with international standards (EN 16001, ISO 50001) from 2013. In addition, successful financial support programmes especially for small and medium-sized companies shall be extended, as e.g. the special energy efficiency fund for SMEs.

Example: Evaluation of the KfW program “Special fund for energy efficiency in SME’s”¹⁰

A programme offering partial subsidies for energy audits was launched by the German Ministry of Economics in 2008. It is managed by the KfW, the German Promotional Bank. The purpose of the audits is to identify energy saving potentials in SMEs by qualified and independent consultants. They help to overcome know-how deficits and other obstacles whereas subsidies should encourage SMEs to make use of audits.

Within the program, an initial audit (screening) up to 2 days is subsidized by 80 % of the audit costs, a possible comprehensive audit up to 10 days by 60 %. The evaluation of this programme, which was performed in 2010, shows the effects of the scheme and gives recommendations for its optimisation. The study focused on empirical research: online surveys of the audited companies, consultants, and the “regional partners” who processed the applications, e.g. chambers of trade and commerce or energy agencies. In addition, final audit reports were analysed. The main aspects of the study were audit quality, implementation of proposed measures, remaining obstacles, and the effects of the programme in terms of energy savings, reduction of CO₂ emissions, and investments.

The study revealed a very good image of the programme and a high implementation rate of the recommendations of the consultants. The consultants found substantial energy efficiency potentials in all the companies. On average, each company implemented 2.8 out of 5.3 recommended measures as a direct result of the energy audit. The total impact of the program with respect to energy savings, CO₂ reductions and induced investments was calculated based on the measures suggested in the audit reports and according to the information given in the company interviews. The impact of these measures was extrapolated by multiplying the savings with the total number of companies participating in the programme (Figure 6.2).

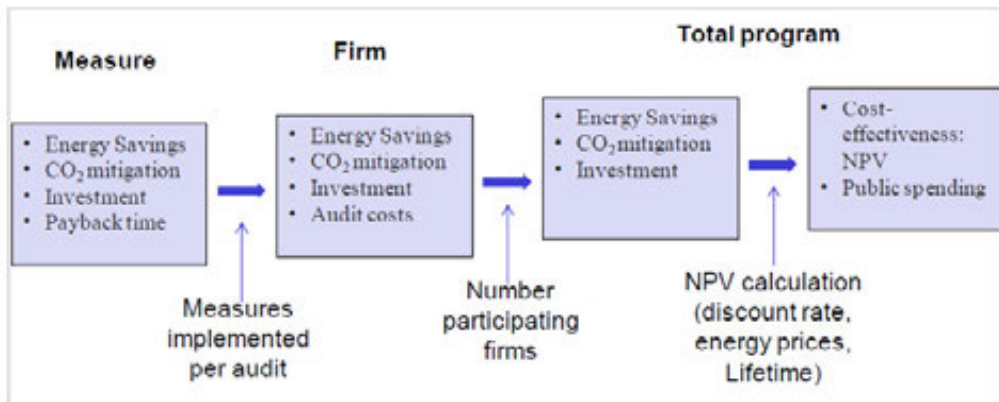

Figure 6.2 - Impact assessment of the programme: calculation approach

In total, the measures implemented resulted in 1.4 TWh energy savings per year, 470,000 tons CO₂ reduction, investments of 480 million euros, and energy cost savings of 80 million euros. Programme costs amount to 0.5-0.7 euro/MWh energy saved. Success factors of the audit scheme include its low threshold access caused by the high level of funding, the support from the regional partners and their personal contacts to SMEs, and the generally high quality of the audits. The authors recommend to optimise the KfW consultants’ list in the internet with regard to the search for competent consultants, especially those with know-how of branch-specific process technologies, and to improve further the audit reports by a more detailed specification of the content.

6.8 COUNTRY OUTLOOK: SWEDEN

6.8.1 TOTAL FINAL ENERGY USE

In 2011, total final energy use amounted to 379 TWh, which is a reduction of 4% from 2010. The industrial sector and the residential and services sector each used the same amount of energy, 144 TWh. This is a reduction of about 7 per cent for the residential and services sector compared with 2010. Energy use in the residential and services sector is affected in the short-term by, primarily, the outdoor temperature as a large proportion is used for heating. Energy use in the transport sector amounted to 90 TWh, which is almost the same as in

2010. Electricity is the dominant type of energy used in Sweden, and total final electricity use in 2011 was 126 TWh. The residential and services sector used the largest amount of electricity, followed by the industrial sector.

6.8.2 THE INDUSTRIAL SECTOR

Energy use in the industrial sector decreased by 2%, to 144 TWh, in 2011 compared with 2010. This means that the industrial sector was responsible for 38% of Sweden's final energy use. The energy used by Swedish industry comes primarily from the energy sources biofuels and electricity. In 2011, these accounted for 38 and 37%, respectively, of the industrial sector's final energy use. Fossil fuels such as oil products, coal, coke and natural gas constituted 22% of the total energy used by Swedish industry.

6.8.3 SWEDEN PROGRAMME FOR IMPROVING ENERGY EFFICIENCY IN ENERGY INTENSIVE INDUSTRIES (PFE)

The Programme was introduced on January 1st 2005 as part of a voluntary agreement between industry and government. The programme aims to increase energy efficiency in energy intensive industries with a focus on electricity consumption. Energy-intensive companies in the manufacturing industry can be granted tax exemption on their electricity consumption (0,55 € per MWh) if they take action to improve their energy efficiency under the PFE. In the first two years, the company must obtain certification for a standardized energy management system (ISO 50001 or EN 160001) and introduce energy efficiency screening procedures for the purchasing of high-consumption electrical equipment. It must also carry out an energy review, which identifies a list of EE opportunities. In the following three years the company must implement the EE measures identified thanks to the mandatory energy review. The company is also required to submit a report to the Swedish Energy Agency on the energy management system in place (EN 16001 or ISO 50001), the energy review that has been undertaken and the list of measures identified. At the end of the five years another report must be submitted to the Swedish Energy Agency. This report should describe and summarize the actual result of the implemented measures.

6.8.4 THE SWEDISH ENERGY AGENCY

SEA is a government agency for national energy policy issues. The Agency's headquarters are in Eskilstuna and we are around 350 employees.

Our mission is to promote the development of Sweden's energy system so that it will become ecologically and economically sustainable. This means that energy must be available at competitive prices and that energy generation must make the least possible impact on people and the environment. The Swedish Energy Agency supports research and development about the supply, conversion, distribution and use of energy. Assistance is also provided to development of new technologies. The Agency is involved in broader international energy research cooperations, which among other things, is about the increased use of renewable energy sources and development of new technologies and systems for energy supply. The Swedish Energy Agency also provides practical assistance and, in some cases, support for the applications to the various energy programmes in EU.

COOLSAVE

Development and dissemination of cost-effective strategies to improve energy-efficiency in cooling systems in the food and drink sector

COOL-SAVE is an **innovative project** which aims at **reducing industrial energy consumption in cooling installations** by vapor-compression mechanical system in the food and drink sector, through the dissemination of **cost-effective energy-efficiency strategies implementation**.

The main objective; to **optimize the vapor-compression mechanical systems** in the food and drink sector.

New Refrigeration plant energy-efficiency diagnostic webtool

- Calculate estimated potential energy savings
- Develop a customized improvement strategy

Sign up online at cool-save.eu/webtool



Have your say!

Are you a refrigeration professional?

Do you have something to say about energy savings in commercial refrigeration applications?

Take the **COOL-SAVE survey today** at cool-save.eu

Get involved in one of the leading European projects on energy saving strategies for cooling systems.

Before getting started, why not view the presentation on *"Economic and technical feasibility of generic energy efficiency optimization solutions."*

REFERENCES

- UK National Energy Efficiency Action Plan (2014-2015)
<https://www.gov.uk/government/publications/energy-action-plan-2014-to-2015>
- Department of Energy & Climate Change (DECC)
<https://www.gov.uk/government/organisations/department-of-energy-climate-change/about>
- DECC Departmental Improvement Plan 2014
https://www.gov.uk/government/uploads/system/uploads/attachment_data/file/307539/DECC_Departmental_Improvement_Plan_April2014_Final_2_.pdf
- Community energy (UK)
<https://www.gov.uk/community-energy>
- Urban Community Energy Fund (UK)
<https://www.gov.uk/urban-community-energy-fund>
- Green Deal: energy saving for your home (UK)
<https://www.gov.uk/green-deal-energy-saving-measures>
- IDEAS: energy innovation awards in renewable energy, energy efficiency and energy access in the Caribbean (UK)
<https://www.gov.uk/ideas-energy-innovation-awards-in-renewable-energy-energy-efficiency-and-energy-access-in-the-caribbean>
- VAT for builders (UK)
<https://www.gov.uk/vat-builders/energy-mobility>
- Capital Markets Climate Initiative (UK)
<https://www.gov.uk/capital-markets-climate-initiative>
- Energy Entrepreneurs Fund (UK)
<https://www.gov.uk/government/collections/energy-entrepreneurs-fund>
- Innovation: apply for a funding award (UK)
<https://www.gov.uk/innovation-apply-for-a-funding-award>

- England 2014 to 2020 European Structural and Investment Funds Growth programme (UK)
<https://www.gov.uk/government/publications/england-2014-to-2020-european-structural-and-investment-funds-growth-programme-handbook/england-2014-to-2020-european-structural-and-investment-funds-growth-programme-handbook>
- Innovate UK
<https://interact.innovateuk.org/>
- Új Széchenyi Terv (HU)
<http://www.ujszecenyiterv.hu/>
<http://www.ujszecenyiterv.hu/palyazat/vallalkozasfejlesztési-program/mikro-es-kis-es-kozepvallalkozasok-technologia-fejlesztése.php>
<http://www.ujszecenyiterv.hu/palyazat/vallalkozasfejlesztési-program/komplex-vallalati-technologia-fejlesztés-mikro-kis-es-kozepvallalkozasok-számára-kozep-magyarországi-regioban.php>
<http://www.ujszecenyiterv.hu/palyazat/vallalkozasfejlesztési-program/komplex-vallalati-technologia-fejlesztés-mikro-kis-es-kozepvallalkozasok-számára-khg-kmr.php>
<http://www.ujszecenyiterv.hu/palyazat/vallalkozasfejlesztési-program/komplex-vallalati-technologia-fejlesztés-mikro-kis-es-kozepvallalkozasok-számára.php>
<http://www.ujszecenyiterv.hu/palyazat/vallalkozasfejlesztési-program/komplex-technologia-fejlesztés-es-foglalkoztatás-támogatása.php>
<http://www.ujszecenyiterv.hu/palyazat/vallalkozasfejlesztési-program/az-üzleti-infrastruktúra-es-a-befektetési-környezet-fejlesztése-eszak-magyarországi-regioban.php>
- Darányi Ignác Terv (HU)
<http://www.umvp.eu/category/tagek/daranyi-ignac-terv>
- Közép-Dunántúli Operatív Program, Industry building component, Identification number: KDOP-1.1.1/D-13 (HU)
<http://palyazatmenedzser.hu/2014/01/05/ipartelepites-kdop-111d13/>

- Horizon 2020 Dedicated SME Instrument - Phase 1 2014 (HU): <http://ec.europa.eu/research/participants/portal/desktop/en/opportunities/h2020/calls/h2020-smeinst-1-2014.html>
- Call for Innovation Proposals 2014-2 (HU) <http://cip2014.kic-innoenergy.com/>
- Ministry of National Development (2013): Hungary to utilize 2014-2020 EU funds in a more concentrated way, 2013.02.07 <http://magzrt.hu/node/1664>
- Hungarian energy strategy 2030 <http://2010-2014.kormany.hu/download/a/b7/70000/Hungarian%20Energy%20Strategy%202030%20Summary.pdf>
- Smil V., Energy in nature and society - General energetic of complex systems. MIT Press, Cambridge, Massachusetts, 2008
- 2010 Report of the refrigeration, air conditioning and heat pumps technical options committee
- Clodic D., Barrault S. 1990 to 2010 Refrigerant inventories for Europe Previsions on banks and missions from 2006 to 2030 for the European Union Executive Summary

LIST OF ABBREVIATIONS

APC	Advanced Propulsion Centre
BBSRC	Biotechnology and Biological Sciences Research Council
BIS	Department for Business, Innovation and Skills
CHP	Combined Heat and Power
CMCI	Capital Markets Climate Initiative
CO ₂	Carbon dioxide
CP	Climate Public
DECC	Department of Energy and Climate Change
Defra	Department for Environment, Food and Rural Affairs
DFID	Department for International Development
EIT	European Institute of Innovation and Technology
ESIF	European Structural and Investment Funds
EU	European Union
FITs	Feed-in Tariffs
FSA	Food Standards Agency
G8	Group of Eight
GAP	Good Agricultural Practices
GVEP	Global Village Energy Partnership
HNDU	Heat Networks Delivery Unit
HUF	Hungarian forint
IDB	Inter-American Development Bank
IP	Intellectual Property
KIC	Knowledge, Innovation, Community
KTPs	Knowledge Transfer Partnerships
MRC	Medical Research Council
NERC	Natural Environment Research Council
PMR	Partnership for Market Readiness
R&D&I	Research&Development&Innovation
RCEF	Rural Community Energy Fund
RHI	Renewable Heat Incentive
SMEs	Small and medium sized companies
UCEF	Urban Community Energy Fund
UK	United Kingdom
VAT	Value-added tax

REFRIGERATION PLANTS ENERGY EFFICIENCY DIAGNOSTIC WEB TOOL



9.1 WEB TOOL DESCRIPTION

This application is a web tool that calculates, on an estimated basis, the potential energy savings for an industrial refrigeration facility in the food and drink sector. As a result, a report with a list of customized improvement strategies based on the information entered in the web tool is generated. The application consists of a simple questionnaire where energetic, economic and technical data on the refrigeration plant is requested. With the information entered, a simple energetic analysis is performed, and as a result, a list of the best viable energy improvement options is offered for each facility. Each improvement strategy is accompanied by an estimation of the annual maximum and minimum energy and cost savings.



9.1.1 MAIN PAGE

Just by clicking on <http://www.cool-save.eu/webtool>, you can obtain your personal report:



This main web page allows you to log in if you are already registered. Otherwise you can sign up creating a new account. The same Company can have several businesses, so it is possible to generate different reports for different cooling plants, but you cannot create several accounts for the same business.

9.1.2 LOGIN PAGE

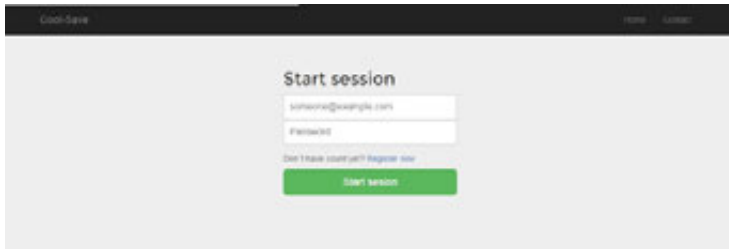

- ▶ **User:** It is your registered Email.
- ▶ **Password:** Your password.

After registering you can fill in a new form or visualize reports you have already generated.

9.1.3 AVAILABLE REPORTS

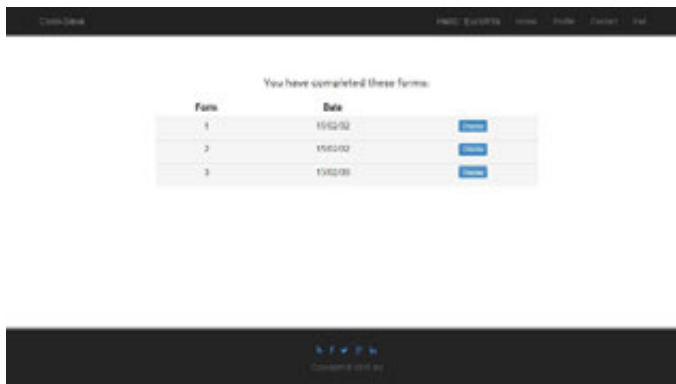

Completed forms are available by clicking on 'display', and if you decide to save it, you can export it to PDF.

9.1.4 FILL IN A REPORT

All sections are multi select, so you can choose multiple options with checkboxes. If you decide to select the ‘other’ option you must explain to us why you had selected this option. To fill in the form it is necessary to complete each section, if not, it will show an error.

9.1.5 FINAL REPORT

Once all the information is completed, you will obtain a personal report similar to the one shown in this example. The report includes a list of feasible improvement strategies. Each strategy is completed with the following information:

- ▶ Maximum and minimum percentage of energy saving potential
- ▶ Maximum and minimum potential of money to save

The new type of equipment necessary to add or implement to improve the refrigeration plant’s energy efficiency.

Cool-Save Help Funcións Home Contacto

Strategy suggested	% Energy saving		Money saving		New equipment to add
	min	max	min	max	
Improvement of general plant					
- Recover refrigeration oil's heat	3%	3%	2.571K	6.857K	New insulation
Improvement in pumping system					
- Installation of variable speed devices (VSD) in pumps	2%	4%	1.714K	3.428K	VSD in pump
- Optimize control of pump	0,35%	1%	300K	657K	Configuration parameters
Improvement in chiller equipment					
- Optimize compressors control system	13,50%	16%	11.571K	15.428K	Configuration parameters
- Optimize parameter control of the chiller	3%	5%	2.571K	4.286K	Configuration parameters
- Temperature variable de las embrazadas (carga de bapa)	2,5%	6%	2.057K	5.143K	Configuration parameters
- Set number of operating chiller equipment for optimal efficiency on cooling facilities	10%	12,5%	8.571K	10.714K	Configuration parameters

[Download pdf](#)

Generado el 20/10/2011

With just one click you can export your personal report to PDF.

Informe 342.352/1437.pdf - Adobe Acrobat Pro

Archivos Editar Ver Ventanas Ayuda Personalizar

Herramientas Firmas Comentario

COOL-SAVE

Strategy suggested	% Energy saving		Money saving		New equipment to add
	min	max	min	max	
Improvement of general plant					
- Recover refrigeration oil's heat	3%	3%	2.571K	6.857K	New insulation
Improvement in pumping system					
- Installation of variable speed devices (VSD) in pumps	2%	4%	1.714K	3.428K	VSD in pump
- Optimize control of pump	0,35%	1%	300K	657K	Configuration parameters
Improvement in chiller equipment					
- Optimize compressors control system	13,50%	16%	11.571K	15.428K	Configuration parameters
- Optimize parameter control of the chiller	3%	5%	2.571K	4.286K	Configuration parameters
- Temperature variable de las embrazadas (carga de bapa)	2,5%	6%	2.057K	5.143K	Configuration parameters
- Set number of operating chiller equipment for optimal efficiency on cooling facilities	10%	12,5%	8.571K	10.714K	Configuration parameters

[Download pdf](#)

Generado el 20/10/2011

Art. 14.01011
 Refrigeration Plant Energy Efficiency Diagnostic Method
 2013-02-27 22:38:37

COOLSAVE

Development and dissemination of cost-effective strategies to improve energy-efficiency in cooling systems in the food and drink sector

COOL-SAVE is an **innovative project** which aims at **reducing industrial energy consumption in cooling installations** by vapor-compression mechanical system in the food and drink sector, through the dissemination of **cost-effective energy-efficiency strategies implementation**.

The main objective; to **optimize the vapor-compression mechanical systems** in the food and drink sector.

New Refrigeration plant energy-efficiency diagnostic webtool

- Calculate estimated potential energy savings
- Develop a customized improvement strategy

Sign up online at cool-save.eu/webtool



Have your say!

Are you a refrigeration professional?

Do you have something to say about energy savings in commercial refrigeration applications?

Take the **COOL-SAVE survey today** at cool-save.eu

Get involved in one of the leading European projects on energy saving strategies for cooling systems.

Before getting started, why not view the presentation on *"Economic and technical feasibility of generic energy efficiency optimization solutions."*

FACTSHEETS

CASE STUDIES FROM AUDITED PLANTS

Within the project life 25 cooling plant systems were visited and studied in order to carry out a statistical analysis by using mainly 5 criteria:

- ▶ climate zones
- ▶ 8 refrigerants
- ▶ 3 types of compression
- ▶ 3 types of condensation
- ▶ 2 types of evaporation

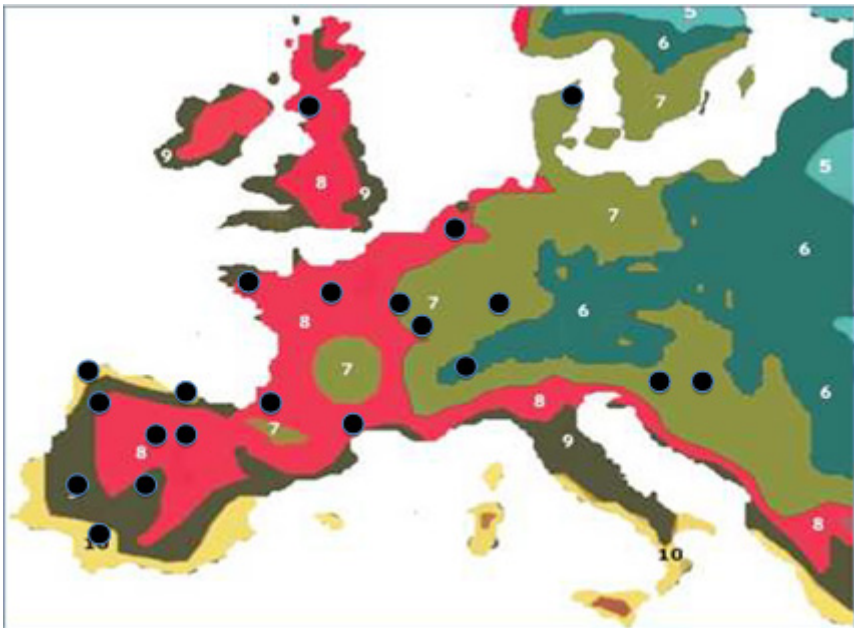

A series of short Factsheets have been summarized as best practice examples for the food & drink SMEs which would like to have a model to follow and to compare to their current situation, in order to promote one of the aforementioned energy saving strategies.

Improvement of compressors efficiency

Installation of variable speed device (VSD)

Why?

In large industrial refrigeration plants, compressors constitute the major part of energy consumption, making them main equipment requiring energy improvement. Electric consumption of compressors compared to all refrigeration equipment in the industry is between 60% and 90%. Compressors, the most important equipment in the refrigeration industry, when used correctly, can increase performance in refrigeration facilities.

What?

Refrigeration demand fluctuates, so equipment has high variations in the load which penalize performance. Thanks to **variable speed device (VSD)**, it is possible to reduce electricity consumption in equipment. However, this requires an important financial investment, and also, during modification, the equipment must remain off:

- VSD on reciprocating compressors: consists in combining the modification of the number of active cylinders in the compressor and the change in rotational speed of the motor
- VSD on screw compressor: these provide a better adjustment than in reciprocating compressors. The mechanical capacity control system (0-100%) is combined with the setting of the rotational speed of the electric motor



Equipment requirements

- Typically one VSD per compressor. The VSD controls the load in the compressor
- Sufficient programming capability in the control system to facilitate effective speed control logic.

Investment return

The capital costs of implementing variable speed device (VSD) depend on the following:

- Size of variable speed device
- Location of variable speed devices relative to the compressor motor. If practical reasons dictate larger distances, capital costs increase due to the need for greater quantities of shielded cabling.

Estimated cost, €			
Item	Equipment, €	Labour, €	TOTAL, €
(VSD)	11.000	6.500	17.500

Note: The cost of the equipment includes a 200 kW VSD, the labour and engineering of the installation

Feasibility study

Electric consumption before of the strategy, kWh/year	% saving	Economic saving, Euros/year		Payback, years	
	Min - Max	Min	Max	Min	Max
4.000.000	1,16 – 3,0%	4.176	10.800	4,19	1,62

Note: We estimate cost of electricity at 0.09 € / kWh and 4 million kWh/year of electric consumption



Improvement of compressors efficiency

Optimize compressors working cycle

Why?

In large industrial refrigeration plants, compressors never work under the same working conditions because weather conditions and refrigeration needs vary. As a result, there will often be times when the compressors cycle is not optimal and will be oversized or undersized.

What?

The blue line in the graph represents the instant consumption electric power for a refrigeration plant in regular use, while the green line in the graph represents the instant consumption electric power for the same refrigeration plant, but with an optimized compressors working cycle. If you optimize the cycle of the compressors, you obtain the same refrigeration capacity, but you reduce electric consumption and spend less money resulting in increased refrigeration plant performance.

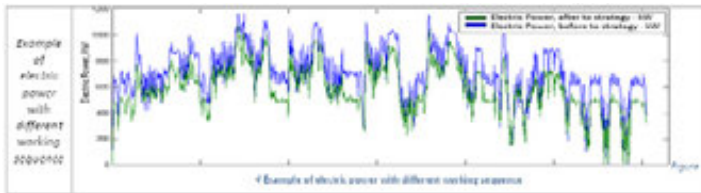

Equipment requirements

- Module (Software)

Investment return

The capital costs of implementing module (software) depend on the following:

Estimated cost, €			
Item	Equipment, €	Labour, €	TOTAL, €
Module (software)	15.000		15.000

Note: The cost of this strategy includes the labour and engineering of the installation

Feasibility study

Electric consumption before of the strategy, kWh/year	% saving	Economic saving, Euros/year		Payback, years	
	Min - Max	Min - Max		Min - Max	
4.000.000	15 - 20%	54.000	72.000	0,28	0,21

Note, we estimate cost of electricity at 0,09 € / kWh and 4 million kWh/year of electric consumption



Supported by
INTELLIGENT ENERGY EUROPE



Development and dissemination of cost effective strategies to improve energy efficiency in cooling systems in the food and drink sector

Condensers efficiency Improvement

Optimize condenser control system (PID, start-ups ...)

Why?

In large industrial refrigeration plants, the heat to dissipate in condensers varies. In addition, the compressors load conditions and weather conditions differ. If the condenser control system is not optimized for these conditions, the operation of condensers will not be suitable. Optimizing condenser control system for real working conditions will reduce compressors energy consumption.

What?

Condensing pressure without an optimized condenser control system is very unstable, and performance of the refrigeration plant will be reduced.

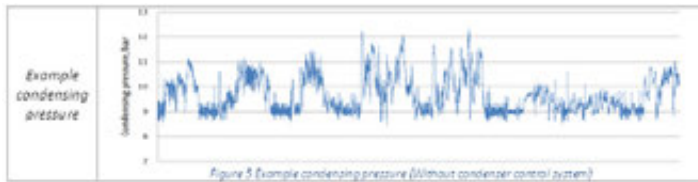

To control condensers a Proportional-Integral-Derivative (PID) is used to achieve the condensing pressure set point:

- PID + configured When you install a PID, you have to configure its parameters correctly. This strategy is completed when you configure the condensers working parameters.
- Start-ups + configured

Equipment requirements

- PID + PID Configured + start-ups Configured

Investment return

The capital costs of implementing module (software) depend on the following:

Estimated cost, €			
Item	Equipment, €	Labour, €	TOTAL, €
PID Configured	600	13.000	13.600

Note: The cost of the equipment includes PID, the labour and engineering of the installation

Feasibility study

Electric consumption before the strategy, kWh/year	% saving	Economic saving, Euros/year		Payback, years	
	Min - Max	Min - Max		Min - Max	
4.000.000	0% (Increased stability for discharge pressure)	-	-	-	-

Note, we estimate cost of electricity at 0.09 € / kWh and 4 million kWh/year of electric consumption



Improvement of cooling plant lines efficiency

Installation of variable speed devices in pumps (VSD)

Why?

In large industrial refrigeration plants, energy consumption of the plant lines is low compared to other equipment, such as pumps, evaporators-chamber, defrost... In industry, electric consumption of this equipment is between 5% and 15% compared to all electric consumption in the plant.

What?

The cooling services in a refrigeration plant are not constant, so a VSD can be installed in pumps of cooling services to adjust real capacity of the pump with demand. During the modification, the equipment must remain off. Many pumps lack the variable speed device (VSD), so they only work on/off. Consequently, to correctly adjust the cooling demand and the flow rate in the pumps, a variable speed device (VSD) should be installed.

Equipment requirements

- Typically one VSD per pump. The VSD would control the load capacity in the pump
- Sufficient programming capability in the control system to facilitate effective speed control logic.

Investment return

The capital costs of implementing variable speed device (VSD) depend on the following:

- Size of variable speed device

Estimated cost, €			
Item	Equipment, €	Labour, €	TOTAL, €
Variable speed device	750	3.000	3.750

Note: The cost of the equipment includes a 3 kW VSD, the labour and engineering of the installation

Feasibility study

Electric consumption before of the strategy, kWh/year	% saving	Economic saving, Euros/year		Payback, years	
	Min - Max	Min - Max		Min - Max	
4.000.000	2 - 4%	7.200	14.400	0,52	0,26

Note, we estimate cost of electricity at 0.09 € / kWh and 4 million kWh/year of electric consumption



Supported by
INTELLIGENT ENERGY EUROPE



Development and dissemination of cost effective strategies to improve energy efficiency in cooling systems in the food and drink sector

Improvement of global plant efficiency

Installing cascade or Multi-stage system (CO₂-NH₃)

Why?

In applications demanding very low temperatures, the pressure ratio required is very high. Compressors have poor efficiency at very high compression ratios, making single-stage cycles working at very low evaporating temperatures inefficient. To overcome this problem, two-stage systems are often employed, using two compressors each with a more efficient compression ratio.

What?

It can be seen that the total work being performed by the compressors in the multi-stage system is lower than in their single-stage counterpart, while the cooling effect is higher.

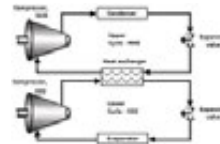
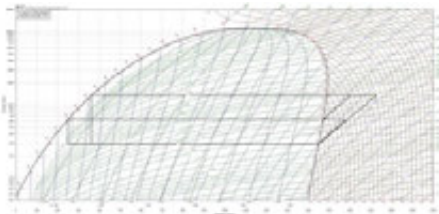

Advantages

The overall efficiency of a CO₂ – NH₃ cascade system is better compared to a traditional NH₃ system, when the refrigerant temperature is below -40°C down to -54°C. Replacing big amounts of NH₃ in the plant with another refrigerant with less potential risk is another advantage of the system. NH₃ charge is reduced to a minimum and is only located in the machinery room.

This system is suitable for new installations, particularly in applications for deep freezing where evaporating temperatures of -50°C are easily reached, thus decreasing freezing times or increasing tons of frozen products.

Disadvantages

In steady state operation, saturated pressure can be very high, so it should be under control. A small separate refrigeration system is required to maintain saturated pressure under the design pressure during steady state. CO₂ hot gas defrost demands special attention due to high defrosting pressures. CO₂ replaces air and causes lack of oxygen so leakage detection systems are necessary.

It is difficult to implement this solution in an existing brine refrigeration system because the high design pressure invalidates existing equipment.



Supported by
INTELLIGENT ENERGY EUROPE



Development and dissemination of cost effective strategies to improve energy efficiency in cooling systems in the food and drink sector

Improvement of global plant efficiency

Equipment requirements

The following equipment is required: Implementing a cascade or multi-stage system (CO₂-NH₃) depend on the following:

- 500 kW, NH₃ cooling capacity
- 350 kW, CO₂ cooling capacity
- Heat exchanger

Investment return

The capital costs of implementing a cascade or multi-stage system (CO₂-NH₃) depend on the following:

- Cooling capacity of the system

Estimated cost, €			
Item	Equipment, €	Labour, €	TOTAL, €
Cascade system CO ₂ -NH ₃	500.000	30.000	530.000

Note: The cost of the equipment includes a 500 kW of NH₃ cooling capacity, 350 kW of CO₂ cooling capacity as well as a heat exchanger, labour and engineering of the installation

Feasibility study

Electric consumption before of the strategy, kWh/year	% saving	Economic saving, Euros/year		Payback, years	
	Min - Max	Min - Max		Min - Max	
4.000.000	11 - 15%	39.600	54.000	13,38	9,81

Note. we estimate cost of electricity at 0.09 € / kWh and 4 million kWh/year of electric consumption



Development and dissemination of cost effective strategies to improve energy efficiency in cooling systems in the food and drink sector

Improvement of global plant efficiency

Optimized system control

Why?

Optimization of the logic control across the full range of plant operating conditions is essential in order to achieve the greatest level of energy savings from each technology. As a rule, such optimization requires that the performance of the logic control be continuously monitored and the various control parameters fine-tuned over an extended period so as to capture variations in production and seasonal conditions.

Where the logic is implemented on the plant's computer, "static optimization" (optimization under one set of conditions at the time of implementation) is commonly applied.

What?

In the industrial refrigeration sector, there is a product that dynamically optimizes configuration parameters of all equipment in an industrial refrigeration plant, ensuring continuous maximum performance. This product is the IRS & IRC of ITCL "Instituto Tecnológico de Castilla y Leon",

- **IRS, Industrial Refrigeration Supervision**

With the IRS, both performance of all equipment in the refrigeration plant can be continuously monitored as well as overall plant performance.



Supported by
INTELLIGENT ENERGY EUROPE



Development and dissemination of cost effective strategies to improve energy efficiency in cooling systems in the food and drink sector

Improvement of global plant efficiency

Also, the cooling production, electric consumption, flow rate or System Efficiency Index (SEI) of all compressors remains visible.

- **IRC, Industrial Refrigeration Control**

The IRC software configures all parameters of all equipment in the refrigeration plant, ensuring continuous performance.

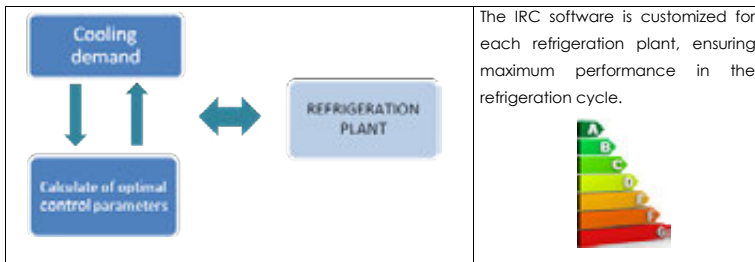

Optimal performance is available at any moment with the same cooling capacity in refrigeration plants because this software calculates the optimal control parameters continuously.

Equipment requirements

- Module (Software)

Investment return

The capital cost of implementing optimized system control depends is as follows:

Estimated cost, €			
Item	Equipment, €	Labour, €	TOTAL, €
Module (software)	35.000		35.000

Note: The cost of this strategy includes labour and engineering of the software installation

Feasibility study

Electric consumption before of the strategy, kWh/year	% saving	Economic saving, Euros/year		Payback, years	
	Min - Max	Min	Max	Min	Max
4.000.000	15 - 40%	54.000	144.000	0,65	0,24

Note, we estimate cost of electricity at 0.09 € / kWh and 4 million kWh/year of electric consumption



Supported by
INTELLIGENT ENERGY EUROPE



Development and dissemination of cost effective strategies to improve energy efficiency in cooling systems in the food and drink sector

Improvement of global plant efficiency

Repairing any important weak point in the pipe system thermal insulator between the high stage liquid separator and the services

Why?

In large industrial refrigeration plants, repairing thermal insulation can be added to other energy saving strategies such as replacing and improving equipment parts in the overall refrigeration plant.

What?

If the thermal insulation is in poor condition or is broken, frosting can occur on the pipes or low pressure receiver. You can see in the next image a bad thermal insulation of pipes and receiver, so that ice occurs on the pipes and low pressure receiver.



The thermal insulator of pipes and low pressure receiver should be repaired when in poor condition. By repairing thermal insulation, you reduce energy loss thus improving efficiency of the refrigeration cycle.

Equipment requirements

- Thermal insulation for pipes and low pressure receiver

Investment return

The capital costs of implementing thermal insulation depend on the following:

Estimated cost, €			
Item	Equipment, €	Labour, €	TOTAL, €
10 meters of new thermal insulator with 6" of diameter	1.000	3.000	4.000

Note: The cost of the equipment includes 10 meters of new thermal insulator with 6" of diameter, the labour and engineering of the installation

Feasibility study

Electric consumption before of the strategy, kWh/year	% saving	Economic saving, Euros/year		Payback, years	
	Min - Max	Min - Max		Min - Max	
4.000.000	3 - 8%	10.800 €	28.800 €	0,37	0,14

Note: we estimate cost of electricity at 0.09 € / kWh and 4 million kWh/year of electric consumption



LIST OF FIGURES

Figure 3.1 - Number of enterprises	22
Figure 3.2 - % of industries per country.....	23
Figure 3.3 - % of turnover per country	23
Figure 3.4 - % number of employees per country.....	24
Figure 3.5 - Purchase of energy products (in value).....	24
Figure 3.6 - % of purchased products per country	25
Figure 3.7 - % of industries per climatic zone.....	25
Figure 3.8 - EU Phase Down Profile	27
Figure 3.9 - EU Refrigerant bank from 1990 to 2010.....	30
Figure 3.10 - EU CO ₂ eq. refrigerant emissions.....	30
Figure 3.11 - Overall refrigerant banks from 1990 to 2030 F-Gas Scenario	31
Figure 3.12 - Overall refrigerant banks from 1990 to 2030 F-Gas Plus Scenario..	31
Figure 4.1 - Climate information.....	39
Figure 4.2 - Energy consumption per hour	40
Figure 4.3 - “Power profile” top line during high production hour and lower during low production hours	41
Figure 4.4 - COP variation of a good reciprocating compressor	43
Figure 4.5 - Example of how SEI is an indicator much less sensitive to ambient condition than COP	44
Figure 4.6 - SEI and Sub efficiencies can be visualised and impact of pumps and fans can also be expressed as efficiencies to benchmark performance on a component level and high light where measures are justified.	45
Figure 4.7 - Examples of portable and permanently installed equipment for data collection for thermodynamic evaluation	46
Figure 4.8 - Measuring points and result from thermodynamic analyses.....	47
Figure 5.1 - Electronic Suction regulator.....	54
Figure 5.2 - Evaporator pressure regulator.....	55
Figure 5.3 - Cooling power variable, tall pipes	56
Figure 5.4 - Siphon trap	56

Figure 5.5 - Liquid line.....	57
Figure 5.6 - Pump fluid refrigerant.....	58
Figure 5.7 - Typical single-stage vapour compression cycle	63
Figure 5.8 - Cold side temperature (evaporation) - Decrease in evaporating temperature	66
Figure 5.9 - Warm side temperature (condensation) - Increase in condensing temperature.....	67
Figure 5.10 - Intermediate temperatures and pressures - Single vs. dual-stage cooling cycle.....	67
Figure 5.11 - Normal and high efficiency fans.....	79
Figure 5.12 - Normal control	83
Figure 5.13 - Control with VSD	83
Figure 5.14 - Capacity and power consumption of a screw compressor	86
Figure 5.15 - Power of two compressors in a chiller before and after adjustment of control	95
Figure 5.16 - IRS, industrial refrigeration supervision	98
Figure 5.17 - IRC, industrial refrigeration control.....	98
Figure 5.18 - Global energy ratio for -14°C to -18°C	100
Figure 5.19 - Carnot Coefficient CO ₂ /Carnot Coefficient NH ₃	100
Figure 5.20 - CO ₂ - NH ₃ cascade system	101
Figure 5.21 - CO ₂ - NH ₃ brine system.....	102
Figure 6.1 - Example : a new cooling system based on alternative refrigerants (other than ammonia)	132
Figure 6.2 - Impact assessment of the programme: calculation approach.....	135

LIST OF TABLES

Table 3.1 - Definitions and abbreviations used in this report.....	21
Table 5.1 - Examples of repairing any important weak point in the pipe system (thermal insulation of pipes of refrigeration systems), or other equipment	60
Table 5.2 - Examples of switching the valves at the suction line for others with a lower pressure drop (new high technology valves)	60
Table 5.3 - Examples of resizing the whole pipe system/equipment.....	61
Table 5.4 - Examples of improvement of maintenance	61
Table 5.5 - Examples of repairing any important weak point in the pipe system (thermal insulation of pipes of refrigeration systems), or other equipment	62
Table 5.6 - Examples of switching the valves at the suction line for others with a lower pressure drop (new high technology valves)	62
Table 5.7 - Examples of resizing the whole pipe system/equipment.....	62
Table 5.8 - Examples of improvement of maintenance	63
Table 5.9 - Examples of control and optimization of cooling cycle temperatures and pressures actions	69
Table 5.10 - Examples of control and optimization of cooling cycle temperatures and pressures actions.	70
Table 5.11 - Example of replacement of fans at the condenser.....	72
Table 5.12 - Example of optimization of intermediate pressure in two stage/ cascade systems (CO ₂ -NH ₃ ,...)	73
Table 5.13 - Examples of improvement of condenser efficiency - Installation of variable speed devices (VSD)	73
Table 5.14 - Example of substitution of heat exchanger NH ₃ /CO ₂	73
Table 5.15 - Example of replacement of fans at the condenser.....	74
Table 5.16 - Example of optimization of intermediate pressure in two stage/ cascade systems (CO ₂ -NH ₃ ,...)	74
Table 5.17 - Examples of improvement of condenser efficiency - Installation of variable speed devices (VSD)	74
Table 5.18 - Example of substitution of heat exchanger NH ₃ /CO ₂	74

Table 5.19 - Example of installation of electronic valves after studying the existing expansion (electronic valves).....	76
Table 5.20 - Example of replacement of fans at the evaporators.....	77
Table 5.21 - Example of installation of electronic valves after studying the existing expansion (electronic valves).....	77
Table 5.22 - Example of replacement of fans at the evaporators.....	78
Table 5.23 - Examples: Variable speed at pumps	80
Table 5.24 - Examples: Optimizing secondary loads	81
Table 5.25 - Examples: Variable speed at pumps	81
Table 5.26 - Examples: Optimizing secondary loads	81
Table 5.27 - Example: Installation of high efficiency engines in compressor	88
Table 5.28 - Example: Improvement of compressors' efficiency - Optimize compressors working sequence	88
Table 5.29 - Examples of VSD installation at compressors.....	88
Table 5.30 - Example: Installation of high efficiency engines in compressor	89
Table 5.31 - Example: Improvement of compressors' efficiency - Optimize compressors working sequence	89
Table 5.32 - Examples of VSD installation at compressors.....	90
Table 5.33 - Possible energy saving	96
Table 5.34 - Cost of the strategy implementation, amount of money save and "return on investment".....	96
Table 5.35 - Examples: Optimize compressors' capacity control system.....	104
Table 5.36 - Examples: Improvement of condensers' efficiency - Optimize condensers' working sequences.....	104
Table 5.37 - Examples: Improvement of condensers' efficiency - Optimize the condenser control system	105
Table 5.38 - Examples: Optimize compressors' capacity control system.....	106
Table 5.39 - Examples: Improvement of condensers' efficiency - Optimize condensers' working sequences.....	106
Table 5.40 - Examples: Improvement of condensers' efficiency - Optimize condenser control systems.....	107
Table 5.41 - List of best saving strategies with lowest Return On Investment (ROI).....	107

COOLSAVE

Development and dissemination of cost-effective strategies to improve energy-efficiency in cooling systems in the food and drink sector

COOL-SAVE is an **innovative project** which aims at **reducing industrial energy consumption in cooling installations** by vapor-compression mechanical system in the food and drink sector, through the dissemination of **cost-effective energy-efficiency strategies implementation**.

The main objective; to **optimize the vapor-compression mechanical systems** in the food and drink sector.

New Refrigeration plant energy-efficiency diagnostic webtool

- Calculate estimated potential energy savings
- Develop a customized improvement strategy

Sign up online at cool-save.eu/webtool



Have your say!

Are you a refrigeration professional?

Do you have something to say about energy savings in commercial refrigeration applications?

Take the **COOL-SAVE survey today** at cool-save.eu

Get involved in one of the leading European projects on energy saving strategies for cooling systems.

Before getting started, why not view the presentation on *"Economic and technical feasibility of generic energy efficiency optimization solutions."*